

GUIDE TO CONCRETE OVERLAYS OF ASPHALT PARKING LOTS

SECOND EDITION



IOWA STATE UNIVERSITY
Institute for Transportation

JUNE 2022

National Concrete Pavement
Technology Center



About the CP Tech Center

The mission of the National Concrete Pavement Technology Center (CP Tech Center) at Iowa State University is to unite key transportation stakeholders around the central goal of advancing concrete pavement technology through research, technology transfer, and technology implementation.

Iowa State University Nondiscrimination Statement

Iowa State University does not discriminate on the basis of race, color, age, ethnicity, religion, national origin, pregnancy, sexual orientation, gender identity, genetic information, sex, marital status, disability, or status as a US veteran. Inquiries regarding nondiscrimination policies may be directed to the Office of Equal Opportunity, 3410 Beardshear Hall, 515 Morrill Road, Ames, Iowa 50011, telephone: 515-294-7612, hotline: 515-294-1222, email: eooffice@iastate.edu.

About This Guide

The *Guide to Concrete Overlays of Asphalt Parking Lots*, the first edition of which was published in 2012, provides information for decision-makers and practitioners about selecting, designing, and constructing successful concrete overlays on existing asphalt parking lot pavements. The updated material in this second edition reflects advancements in technology and research, offers a simplified approach to assessing existing pavements, includes modifications to the material on design and construction based on lessons learned, and presents project profiles demonstrating the principles of this guide.

This guide is a product of the National Concrete Pavement Technology Center (CP Tech Center) at Iowa State University's Institute for Transportation. It is a companion document to the fourth edition of the *Guide to Concrete Overlays* (Fick et al. 2021), which provides a thorough overview of overlays for concrete, asphalt, and composite pavements.

For more detailed information about the topics covered in this guide, readers are encouraged to consult the fourth edition of the *Guide to Concrete Overlays*—available along with other documents related to concrete overlays at <https://cptechcenter.org/>—as well as the American Concrete Institute's *Commercial Concrete Parking Lots and Site Paving Design and Construction—Guide*, ACI PRC-330-21.

Reference Information for this Guide

Gross, J., and G. Smith. 2022. *Guide to Concrete Overlays of Asphalt Parking Lots*. 2nd Edition. National Concrete Pavement Technology Center, Iowa State University, Ames, IA.

For More Information

National Concrete Pavement Technology Center
Iowa State University Research Park
2711 S. Loop Drive, Suite 4700
Ames, IA 50010-8664
515-294-5798
<https://cptechcenter.org/>

Cover Image Credits

Top: City of Thornton, Colorado, used with permission

Bottom left: Angela James Folkestad, ACPA, CO/WY Chapter, used with permission

Bottom right: Joseph Swederski, Swederski Concrete Construction, Inc., used with permission

Technical Report Documentation Page

1. Report No.	2. Government Accession No.	3. Recipient's Catalog No.	
4. Title and Subtitle <i>Guide to Concrete Overlays of Asphalt Parking Lots</i> (Second Edition)		5. Report Date June 2022	
		6. Performing Organization Code	
7. Author(s) Jerod Gross and Gordon Smith		8. Performing Organization Report No.	
9. Performing Organization Name and Address National Concrete Pavement Technology Center Iowa State University 2711 South Loop Drive, Suite 4700 Ames, IA 50010-8664		10. Work Unit No.	
		11. Contract or Grant No.	
12. Sponsoring Organization Name and Address Ready Mixed Concrete Research & Education Foundation 66 Canal Center Plaza, Suite 250 Alexandria, VA 22314		13. Type of Report and Period Covered Guide	
		14. Sponsoring Agency Code	
15. Supplementary Notes Visit https://cptechcenter.org for color pdfs of this and other research publications.			
16. Abstract <p>The <i>Guide to Concrete Overlays of Asphalt Parking Lots</i> provides information for decision-makers and practitioners about selecting, designing, and constructing successful concrete overlays on existing asphalt parking lot pavements that serve public, commercial, or multifamily residential buildings. The guide focuses on parking areas that carry and store light vehicles (primarily automobiles and pickup trucks), but it also addresses adjacent access roads and truck lanes that regularly carry heavy trucks for the delivery and pickup of goods and materials, including solid waste containers.</p> <p>This document offers expert guidance to supplement practitioners' own professional experience and judgment. With this information, parking lot owners can confidently include concrete overlays in their toolbox of asphalt parking lot maintenance solutions and make informed decisions about overlay design and construction based on existing asphalt conditions.</p> <p>The following material has been updated or added for the second edition of this guide:</p> <ul style="list-style-type: none"> • The information on pavement assessment has been simplified. • Information has been added on designing around fixed elevations. • An overlay strategy flowchart has been added. • The information on macrofibers has been updated. • Project profiles demonstrating the principles of this guide have been added. • Information has been added on laser-guided screed texture and cure equipment. • Information on distress identification and the key points of materials and construction have been relocated to appendices. 			
17. Key Words concrete overlays—parking lot overlays—parking lot pavements		18. Distribution Statement Printed copies are available through National Ready Mixed Concrete Association.	
19. Security Classification (of this report) Unclassified.	20. Security Classification (of this page) Unclassified.	21. No. of Pages 69	22. Price NA

Guide to Concrete Overlays of Asphalt Parking Lots

(Second Edition)

June 2022

Authors

Gordon Smith, National Concrete Pavement Technology Center

Jerod Gross, Snyder & Associates, Inc.

Contributing Author

Jon Hansen, National Ready Mixed Concrete Association

Technical Reviewers

Brian Killingsworth, National Ready Mixed Concrete Association

Don Clem, National Ready Mixed Concrete Association

Jennifer LeFevre, Ready Mixed Concrete Research & Education Foundation

Gerald Welch, FORTA Corporation

Managing Editor

Oksana Gieseeman, Institute for Transportation

Editor

Peter Hunsinger, Institute for Transportation

Graphic Design and Layout

Alicia Hoermann, Institute for Transportation

Sponsored by

Ready Mixed Concrete Research & Education Foundation

A guide from

National Concrete Pavement Technology Center

Iowa State University

2711 South Loop Drive, Suite 4700

Ames, IA 50010-8664

Phone: 515-294-5798 / Fax: 515-294-0467

<https://cptechcenter.org>

Acknowledgments

Developing the second edition of the *Guide to Concrete Overlays of Asphalt Parking Lots* has been a collaborative effort. The authors and the National Concrete Pavement Technology Center (CP Tech Center) gratefully acknowledge the support and working partnership of the National Ready Mixed Concrete Association (NRMCA) in identifying necessary updates based on advancements in technology as well as relevant research. Funding was provided by the Ready Mixed Concrete Research & Education Foundation, with technical assistance provided by the NRMCA.

In addition, we appreciate and continue to recognize the invaluable contributions of the extensive technical advisory committee for the first edition of the guide published in 2012. Representing public and private stakeholders from across the country, the committee's members helped establish the technical direction, provided insightful responses to many drafts, and helped shape the content of several sections of the original guide. Many thanks are due to every member of the original technical advisory committee:

- J. Dewayne Allen
- Sybil Ferrier
- Randell C. Riley
- Bryan Birdwell
- Jon Hansen
- Gordon Smith
- David Buzzelli
- Dale Harrington
- David Suchorski
- Tom Cackler
- Don Clem
- Len Swederski
- John Cunningham
- Jerry Holland
- Lori Tiefenthaler
- Norbert Delatte
- Nigel Parkes

Jon Hansen and Gordon Smith deserve special thanks for their efforts in the development of the original guide as well as this update.

Contents

Introduction	1	Details for Concrete Overlays of Asphalt Parking Lots	24
Purpose and Scope of This Guide.....	1	Surface Preparation for Existing Asphalt Pavements	29
Key Terminology and Concepts.....	1	Placement of Concrete Parking Lot Overlays	29
Development of Concrete Overlays of Asphalt Parking Lots from Start to Finish.....	1	Block Placement.....	29
Planning.....	2	Strip Placement.....	29
Design.....	2	Equipment for Parking Lot Overlay Placement	30
Construction.....	2	Equipment for Hand/Wet Screeding.....	30
Maintenance.....	2	Handheld Vibratory Screeds.....	30
Overview of Concrete Overlay Characteristics	3	Roller Screeds.....	31
Considerations Unique to Parking Lot Overlays	5	Vibratory Truss Screeds.....	31
Fixed Elevation Points.....	5	Laser-Guided Screeds.....	31
Traffic Types and Levels.....	6	Equipment for Slipform Paving.....	33
Future Changes in Lot Use.....	6	Equipment for Sawing.....	33
Assessing Existing Pavement Condition	7	Early-Entry Saws.....	34
Step 1. Review Historical Records and Collect Data.....	7	Conventional Saws.....	34
Step 2. Perform a Visual Inspection.....	8	Texturing of Overlay Concrete	35
Identification of Pavement Surface Distresses.....	8	Burlap Drag Texture.....	35
Core Analyses.....	8	Artificial Grass (AstroTurf) Drag Texture.....	35
Optional Analysis of Support Conditions.....	10	Broom Texture.....	35
Step 3. Complete a Pavement Evaluation Report.....	10	Pole Broom Method.....	36
Design of Parking Lot Overlays	11	Pull Broom Method.....	36
Bonded and Unbonded Concrete Overlays.....	11	Boom Broom Method.....	36
Overlay Thickness Design.....	11	Project Profiles of Concrete Overlays of Asphalt Parking Lots	38
Thickness Design for Bonded Concrete Overlays.....	11	Thorncreek Golf Course	
Thickness Design for Unbonded Concrete Overlays.....	13	Thornton, Colorado.....	38
Use of Fibers.....	14	Project Information.....	38
Zone Design for Parking Lot Overlays.....	15	Overview.....	38
Special Design Considerations for Two-Inch-Thick Concrete Overlays.....	16	Denver International Airport	
Jointing for Parking Lot Overlays	20	Denver, Colorado.....	39
Contraction Joints.....	21	Project Information.....	39
Construction Joints.....	21	Overview.....	39
Isolation Joints.....	21	Super Ron's Food Center	
Raising Existing Curb and Gutter Systems	22	Pulaski, Wisconsin.....	40
Construction Considerations.....	22	Project Information.....	40
Curing.....	23	Overview.....	40
Jointing.....	23		

Parker-Hannifin Manitowoc, Wisconsin.....	41
Project Information.....	41
Overview.....	41
References.....	42
Appendix A. Identifying Pavement Distresses and Levels of Severity.....	44
Causes of Distress.....	44
Severity of Distress.....	44
Types of Distress.....	44
Alligator Cracking.....	45
Summary of Possible Causes.....	46
Required Pre-overlay Repairs.....	46
Block Cracking.....	46
Summary of Possible Causes.....	47
Required Pre-overlay Repairs.....	47
Potholes.....	47
Summary of Possible Causes.....	47
Required Pre-overlay Repairs.....	47
Raveling.....	48
Summary of Possible Causes.....	48
Required Pre-overlay Repairs.....	48
Thermal Cracking.....	49
Summary of Possible Causes.....	49
Required Pre-overlay Repairs.....	49
Random Cracking.....	50
Summary of Possible Causes.....	50
Required Pre-overlay Repairs.....	50
Rutting.....	51
Summary of Possible Causes.....	51
Required Pre-overlay Repairs.....	51
Shoving (Slippage).....	52
Summary of Possible Causes.....	52
Required Pre-overlay Repairs.....	52

Appendix B. Fiber-Reinforced Concrete.....	53
Why Fibers?.....	53
Types of Fibers.....	54
High-Volume Synthetic Macrofiber Mixtures.....	55
Construction Considerations When Using Fibers.....	55
Appendix C. Key Points Related to Materials and Construction.....	57
Materials and Mixes.....	57
Pre-overlay Repairs and Surface Preparation.....	59
Construction.....	60

Figures

Figure 1. Concrete overlay on an asphalt parking lot with low- to medium-severity distress.....1	Figure 27. Isolation joint details.....28
Figure 2. Unbonded concrete overlay on an asphalt parking lot with high-severity distress.....1	Figure 28. Dowel or thickened edge joints.....28
Figure 3. Steps for developing a concrete overlay of an existing asphalt parking lot.....2	Figure 29. Block placement.....29
Figure 4. Concrete parking lot in Rio Verde, Arizona (top), with thermal imaging of the same location (bottom) showing the difference in temperature between the concrete lot and the adjacent street paved with asphalt....4	Figure 30. Strip placement.....29
Figure 5. Walmart parking lot in Leavenworth, Kansas, with LED lighting.....4	Figure 31. Striking off with hand/wet screed.....30
Figure 6. Typical schematic of a concrete overlay on an existing parking lot.....5	Figure 32. Concrete vibrator.....30
Figure 7. Flowchart of a pavement condition assessment for an asphalt parking lot7	Figure 33. Handheld vibrating screed.....30
Figure 8. Hammer drilling to check pavement thickness...9	Figure 34. Nonvibrating roller screed.....31
Figure 9. Typical core of asphalt parking lot with granular subbase.....9	Figure 35. Vibratory truss screed.....31
Figure 10. Concrete overlay failure resulting from inadequate information about support conditions.....9	Figure 36. Ride-on boom-style laser-guided screed.....32
Figure 11. Dynamic cone penetrometer.....10	Figure 37. Walk-behind laser-guided screed32
Figure 12. Flowchart for selecting a bonded or unbonded concrete overlay.....12	Figure 38. Laser-guided screed.....32
Figure 13. Concrete overlay of asphalt parking lot with 4 ft by 4 ft panels.....12	Figure 39. Texturing and curing equipment applying curing material.....32
Figure 14. Concrete mix containing synthetic fibers.....14	Figure 40. Placement using a laser-guided screed, with the screed on the left and the texturing and curing equipment on the right.....33
Figure 15. Parking lot with three designated design zones.....15	Figure 41. Slipform paver.....33
Figure 16. Two-inch-thick concrete overlay.....16	Figure 42. Early-entry saws.....34
Figure 17. Example jointing layout for a parking lot....20	Figure 43. Conventional joint saw.....34
Figure 18. Hand placement of a curb and gutter unit...22	Figure 44. Burlap drag texturing and the resulting texture.....35
Figure 19. Completed curb section.....22	Figure 45. Artificial grass (AstroTurf) drag texturing and the resulting texture.....35
Figure 20. Mid-panel cracking above an existing joint in a concrete curb and gutter unit.....23	Figure 46. Broom texture.....35
Figure 21. Control joints for parking lots serving light vehicles.....24	Figure 47. Pole broom method.....36
Figure 22. Sawcut options.....24	Figure 48. Pull broom method.....36
Figure 23. Overlay transition into existing curbs.....24	Figure 49. Finished texture resulting from the pull broom method36
Figure 24. Optional curb details.....25	Figure 50. Boom broom method.....37
Figure 25. Sidewalk ramps and driveways.....26	Figure 51. Finished texture resulting from the boom broom method.....37
Figure 26. Joints at manholes/intakes.....27	Figure 52. Existing asphalt parking lot of the Thorncreek Golf Course before concrete overlay construction.....38
	Figure 53. Completed concrete overlay on the Thorncreek Golf Course parking lot, which provides greater durability and increased reflectivity for better overall performance.....38
	Figure 54. Concrete overlay placement on the Pikes Peak Shuttle Lot at the Denver International Airport, with the existing asphalt pavement used as the base.....39

Figure 55. Completed concrete overlay on the Pikes Peak Shuttle Lot at the Denver International Airport.....39

Figure 56. Asphalt parking lot of Super Ron’s Food Center in Pulaski, Wisconsin, before concrete overlay construction (2020)..... 40

Figure 57. Completed concrete overlay on the parking lot of Super Ron’s Food Center in Pulaski, Wisconsin (2021).....40

Figure 58. Asphalt parking lot of the Parker-Hannifin facility in Manitowoc, Wisconsin, before concrete overlay construction..... 41

Figure 59. Completed concrete overlay on the parking lot of the Parker-Hannifin facility in Manitowoc, Wisconsin (2021).....41

Figure A-1. Thumbnails of asphalt pavement distresses...45

Figure A-2. Low- to medium-severity alligator cracking. 45

Figure A-3. High-severity alligator cracking.....46

Figure A-4. Low- to medium-severity block cracking....46

Figure A-5. High-severity block cracking..... 46

Figure A-6. Low- to medium-severity pothole.....47

Figure A-7. High-severity pothole.....47

Figure A-8. Low- to medium-severity raveling.....48

Figure A-9. High-severity raveling.....48

Figure A-10. Low- to medium-severity thermal cracking..49

Figure A-11. High-severity thermal cracking.....49

Figure A-12. Low- to medium-severity random cracking..50

Figure A-13. High-severity random cracking.....50

Figure A-14. Low- to medium-severity rutting.....51

Figure A-15. High-severity rutting.....51

Figure A-16. Low- to medium-severity shoving.....52

Figure A-17. High-severity shoving.....52

Figure B-1. Close-up of concrete mixture with synthetic fibers.....53

Figure B-2. Synthetic fibers spanning across a sawed joint.....53

Figure B-3. Balling of fibers in a concrete mixture.....54

Tables

Table 1. Subgrade soil types and approximate support values.....10

Table 2. Design thicknesses for unbonded concrete overlays.....13

Table 3. Summary of fiber types.....14

Table 4. Typical bonded concrete overlay thickness over asphalt where mean annual daily temperatures are 45°F to 50°F (e.g., Des Moines, Iowa).....17

Table 5. Typical bonded concrete overlay thickness over asphalt where mean annual daily temperatures are 55°F to 60°F (e.g., Sacramento, California)..... 18

Table 6. Typical bonded concrete overlay thickness over asphalt where mean annual daily temperatures are 65°F to 70°F (e.g., Gainesville, Florida).....19

Table 7. Project information for the Thorncreek Golf Course parking lot overlay.....38

Table 8. Project information for the Denver International Airport parking lot overlay..... 39

Table 9. Project information for the Super Ron’s Food Center parking lot overlay.....40

Table 10. Project information for the Parker-Hannifin parking lot overlay..... 41

Table C-1. Key points related to the materials and mixes used in concrete overlays of asphalt parking lots.....57

Table C-2. Key points related to pre-overlay repairs and surface preparation for concrete overlays of asphalt parking lots..... 59

Table C-3. Key points related to the construction of concrete overlays of asphalt parking lots..... 60

Introduction

Parking lot owners stand to benefit from the proactive, sustainable, long-lasting, and economical strategies for pavement preservation and rehabilitation that concrete overlays represent. With a properly designed and constructed concrete overlay, a distressed or poorly performing asphalt parking lot can be converted into a durable, low-maintenance, and long-life parking structure.

Purpose and Scope of This Guide

This document provides guidance on the design and construction of concrete overlays on asphalt parking lots that serve public, commercial, or multifamily residential buildings. It focuses on parking areas that carry and store light vehicles (primarily automobiles and pickup trucks), but it also addresses adjacent access roads and truck lanes that regularly carry heavy trucks for the delivery and pickup of goods and materials, including solid waste containers.

The expert guidance offered in this guide is intended to supplement practitioners' own professional experience and judgment. With this information, parking lot owners can confidently include concrete overlays in their toolbox of asphalt parking lot solutions and make informed decisions about overlay design and construction based on existing asphalt conditions.

Key Terminology and Concepts

Various terms for concrete overlays, such as ultrathin whitetopping and conventional whitetopping, have led to confusion because they have not been used consistently. This document categorizes all concrete overlays into two systems: bonded and unbonded.

Bonded overlays (which bond with the existing pavement surface so that the new and existing layers act as a monolithic system) are generally appropriate for asphalt parking lots with low- to medium-severity distresses, such as the lot shown in Figure 1. This type of overlay is referred to as a concrete on asphalt–bonded (COA–B) overlay.

Unbonded overlays (which are basically thicker concrete pavements that use the existing asphalt as the base) may be appropriate for asphalt parking lots with high-severity distresses, such as the lot shown in Figure 2, as long as the subgrade soil and subbase granular material (subgrade/subbase) are stable. This type of overlay is referred to as a concrete on asphalt–unbonded (COA–U) overlay.

To ensure satisfactory performance of a new concrete overlay, whether bonded or unbonded, the factors that caused the deterioration of the existing asphalt parking lot need to be corrected or accommodated in the overlay design. An investigation into the probable reasons for the asphalt deterioration is therefore required. Asphalt pavement distresses and failures can generally be attributed to one or more factors: asphalt age, drainage problems, traffic, subgrade condition, an inadequate pavement section, poor construction, an inadequate mixture, or substandard materials.

Development of Concrete Overlays of Asphalt Parking Lots from Start to Finish

In broad terms, the process for developing a concrete overlay of an existing asphalt parking lot involves four basic steps: planning, designing, construction, and maintenance (Figure 3). These steps are summarized below and explored in more detail throughout this guide.



Charles Rohde, King's Material, used with permission

Figure 1. Concrete overlay on an asphalt parking lot with low- to medium-severity distress



Randy Riley, ACPA, IL Chapter, used with permission

Figure 2. Unbonded concrete overlay on an asphalt parking lot with high-severity distress

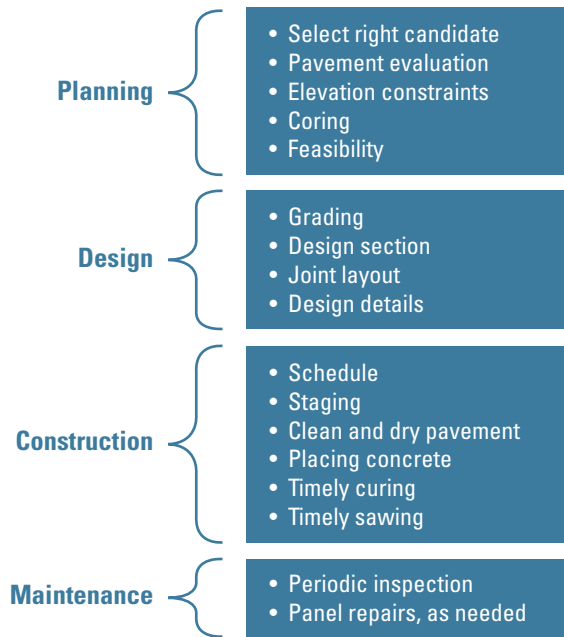

CP Tech Center

Figure 3. Steps for developing a concrete overlay of an existing asphalt parking lot

Planning

A critical step in the planning process is to ensure that an existing pavement is an appropriate candidate for a concrete overlay. This is completed through an evaluation of the pavement. If the pavement distresses are excessively severe, the pavement may not be a good candidate.

Coring of the existing pavement is fundamental to the evaluation process. The information gathered from the core will determine the existing asphalt layers, the presence of potential paving fabrics, and the pavement condition.

Design

Key phases during design include the study of pavement surface elevations and determination of the design pavement thickness. The profile grade of the existing pavement must be analyzed to determine the extent of full-depth reconstruction required near areas that, because of their elevation, cannot accommodate a rise in the pavement grade, including areas near the building frontage. The American Concrete Pavement Association's (ACPA's) Bonded Concrete Over Asphalt (BCOA) Thickness Designer software (<http://apps.acpa.org/applibrary/BCOA/>) is a design tool that has been used successfully to determine bonded concrete overlay thicknesses and establish panel sizes. The software includes the input of macrofibers as a design parameter.

Construction

Rehabilitation of existing retail and commercial parking lots for businesses requires the use of a project schedule to ensure proper coordination and communication with the property owner. Often when an existing parking lot is being rehabilitated, the construction must be staged in order to maintain space for parking during business operations; a staging plan that is acceptable to the property owner is critical.

Before construction of the overlay, the existing pavement should be clean and dry to provide for uniform support conditions and to improve the bonding condition. Proper concrete overlay construction includes good placement practices, timely surface curing, and timely sawing. Due to the relative thinness of the overlay pavement layer, the overlay pavement will reach its final set more quickly than thicker conventional concrete pavements.

Maintenance

After the overlay has been constructed, a good maintenance plan includes periodic inspection to identify the need for potential repairs. If cracking is observed, the overlay panels can be easily replaced by local contractors, encouraging competitive pricing.

Overview of Concrete Overlay Characteristics

Hundreds of successful parking lot projects have demonstrated the versatile characteristics of concrete overlays:

- Concrete overlays can provide both pavement preservation and major rehabilitation solutions—either in and of themselves or in conjunction with spot repairs of isolated distresses, depending on the condition of the existing asphalt pavement—while adding structural capacity to the asphalt parking lot.
- Concrete overlays are long-life, durable solutions, resulting in fewer replacement and repair cycles, lower related costs, and fewer resources, less energy, and fewer raw materials used over time.
- In most cases, minimal pre-overlay repairs are necessary because the concrete overlay itself will fill in or otherwise correct low- to medium-severity distresses. If extensive pre-overlay work is required for a specific project, and spot removals and/or repairs are not cost effective, an overlay may not be the appropriate solution.
- Because of the wide range of overlay thicknesses that can be used, combined with the minimal pre-overlay preparation required, concrete overlays provide cost-effective, adaptable solutions for almost any existing pavement condition, desired service life, and anticipated loads.
- Concrete overlays are placed using normal concrete pavement construction practices. Attention should be paid to the overlay-specific details in this guide.
- Accelerated construction practices can be used throughout the normal construction season, as described in this guide.
- Many concrete overlays can be opened to traffic within a few days, provided strength development is monitored. Nondestructive strength indicators, like maturity testing, enable engineers to take advantage of this benefit.
- Concrete overlays are easy to repair, usually much easier than a section of conventional pavement. If a panel is distressed but is not compromising ride quality or safety, the panel may be left in place. Distressed panels that are reducing ride quality or causing safety issues such as loose concrete should be replaced immediately.
- Overlays constructed without dowel bars can be milled out and replaced with a new concrete surface.
- Concrete overlays are sustainable solutions:
 - With a high solar reflectance or solar reflectivity index (SRI) (sometimes called albedo), concrete absorbs less heat energy from the sun than darker-colored surfaces, as dramatically illustrated in Figure 4. On hot sunny days, therefore, concrete-paved parking lots, roadways, and sidewalks can help mitigate urban heat islands (areas of elevated air temperatures). Heat islands can result in the increased use of energy for air conditioning and increased generation of smog, which exacerbates respiratory conditions such as asthma.
 - Supplementary cementitious materials (SCMs) such as slag cement or light-colored fly ash can be added to concrete to further increase its SRI (Van Dam and Taylor 2009).
 - Concrete's light-colored surface is more reflective than other pavement surfaces, improving visibility and thus safety for both vehicles and pedestrians (Wathne 2010); note the reflected light in Figure 5. Research has indicated that a concrete surface can be as much as 1.77 times more luminous and has a more uniform luminance distribution (Adrian and Jabanputra 2005). As a result, areas paved with concrete require fewer lighting fixtures than other paved surfaces, and less energy (i.e., less wattage) is required to achieve the same degree of lighting. One study determined that, all other factors being equal, a darker-surfaced parking lot required 60 percent more energy than a concrete-surfaced lot (Gajda and VanGeem 2001).
 - Leaks from vehicles—such as gasoline, lubricating oils, and petroleum distillates—do not generally damage mature concrete (Popovics 1986).
 - Concrete hardscaping—such as curbed “greenways” (landscaped areas with trees and other plantings), stamped and/or colored walkways, and other functional but decorative features—enhances parking lot aesthetics.

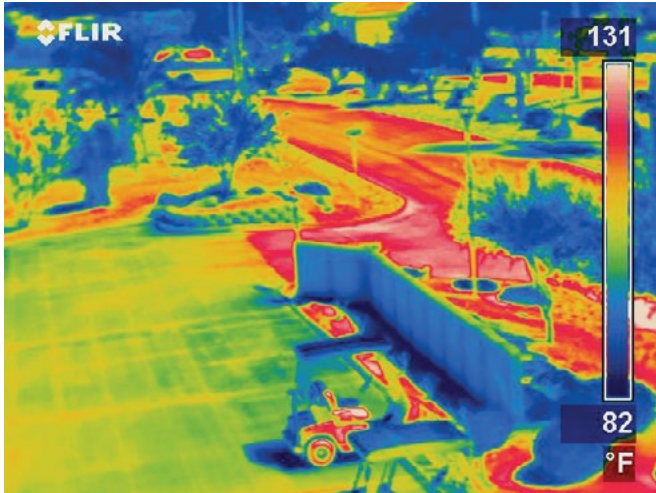

Larry Scofield, ACPA, used with permission

Figure 4. Concrete parking lot in Rio Verde, Arizona (top), with thermal imaging of the same location (bottom) showing the difference in temperature between the concrete lot and the adjacent street paved with asphalt



Jon Hansen, NRMCA, used with permission

Figure 5. Walmart parking lot in Leavenworth, Kansas, with LED lighting

Considerations Unique to Parking Lot Overlays

Many important factors for concrete overlays—load-bearing capacity, drainage, crack control, life-cycle costs, constructability, and maintenance—apply to overlays of both roadway and parking lot pavements, as explained in American Concrete Institute (ACI) publication ACI PRC-330-21, *Commercial Concrete Parking Lots and Site Paving Design and Construction—Guide* (ACI Committee 330 2021). Parking lots, however, have some unique characteristics and considerations that affect design inputs and construction decisions. These considerations include fixed elevation points, traffic types and levels, and future changes in lot use.

Fixed Elevation Points

One of the major efforts in designing concrete overlays for parking lots is determining how to accommodate the fixed elevation points of the curb and gutter system when the overlay raises the pavement elevation. Parking lots can have extensive concrete curb and gutter systems that not only provide drainage but also separate parking zones, outline decorative medians, act as vehicle “bumper blocks,” and delineate the lot perimeter.

In almost all cases, concrete overlays of asphalt parking lots will include areas that must be reconstructed to serve as transition areas into fixed elevation points. For example, because the elevation near a building entrance cannot change, a transition area within the existing pavement must be reconstructed between the fixed elevation points and the overlay, as shown in Figure 6. Drainage structures throughout the lot can be investigated to determine whether modifications are feasible. The elevations of access points to utility structures can typically be adjusted to accommodate the raised elevation of the overlay. Interior light poles can remain in place, with an isolation joint constructed between the new pavement and the adjacent foundation; a minimal increase in pavement elevation will not significantly impact the light levels on the pavement.

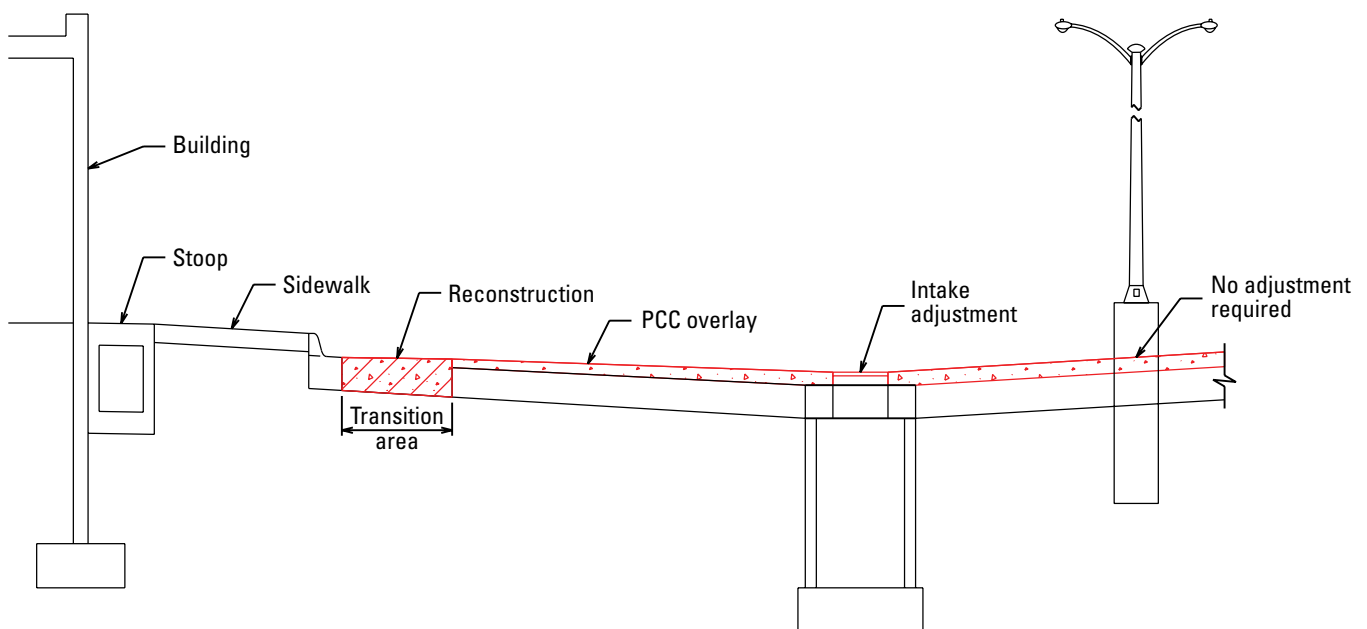

Recreated from Snyder & Associates, Inc., used with permission

Figure 6. Typical schematic of a concrete overlay on an existing parking lot

Traffic Types and Levels

With the exception of access roads and truck lanes for heavy trucks delivering goods or removing waste material, most parking lot areas experience a smaller and lighter spectrum of traffic loadings than roadways and are intended for vehicle storage rather than for moving traffic. Therefore, in general, dynamic impacts are considerably lower on parking lots than on most roadways.

Still, the type of traffic a parking lot carries, and the lot's size, can vary significantly from lot to lot, depending on whether it serves, for example, a convenience store, a multi-unit housing project, a shopping center, or a commercial development. Small lots that do not have separate access or truck lanes may experience occasional or regular heavily loaded truck traffic, which must be considered in the design.

Vehicles in parking areas usually travel at low speeds, diminishing the significance of smoothness tolerances in pavement design. Instead, pedestrian safety is a greater design priority. Clearly designated pedestrian and vehicle lanes or routes, crosswalks, nighttime illumination, and, in some cases, slip-resistant surface textures are important design considerations for parking lot safety, as are traffic calming measures like bumpouts and islands.

Future Changes in Lot Use

Parking lots can be especially prone to changes in use over time based on changes in the function of the buildings they serve. In parking lot overlay design, it is especially important to assess whether loads on the lot or on access roads and truck lanes, or both, will change due to potential future growth or expansion of the facility the lot serves. Schools, for example, may experience increased enrollment, resulting in the expansion of bus routes into parking lot areas originally designed for light vehicles only. Conversion of a business—for example, from a shopping center to a manufacturing facility—may result in a change in parking lot traffic from primarily automobiles and pickup trucks to primarily heavy trucks.

Assessing Existing Pavement Condition

A thorough evaluation of an existing parking lot pavement, including access ways and truck lanes, is always necessary to confirm its suitability for a concrete overlay and, if an overlay is deemed suitable, the appropriate overlay design to address the lot's condition.

To accurately characterize an existing asphalt pavement's condition, the following assessment process is recommended:

1. Review historical records and collect data
2. Perform a visual inspection
3. Complete a pavement evaluation report

This process is outlined in Figure 7 and discussed in more detail in the following sections.

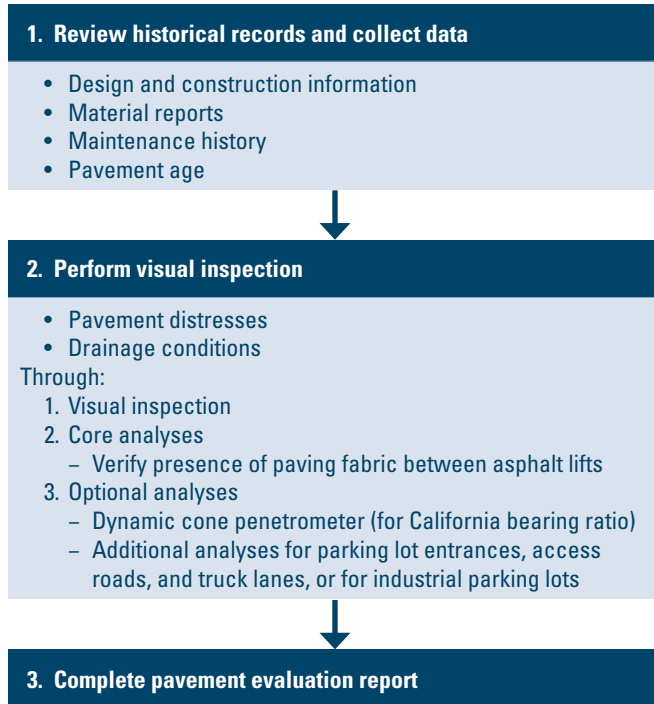

CP Tech Center

Figure 7. Flowchart of a pavement condition assessment for an asphalt parking lot

Step 1. Review Historical Records and Collect Data

The first step is to review historical documents to collect as much recorded information as possible about the existing pavement. This information includes the following:

- Original design data (if available)
- Construction information
- Subgrade/subbase data
- Construction materials testing data

Potential data sources include the following:

- Design reports
- Construction plans/specifications (for new construction and any rehabilitation)
- Previous laboratory test programs and/or published reports that include material and soil properties
- Past pavement condition surveys, nondestructive testing, and/or sampling
- Maintenance/repair histories
- Traffic measurements/forecasts

This step also includes determining future performance requirements, such as expected traffic loadings and desired overlay design life.

Step 2. Perform a Visual Inspection

The second step is to conduct a visual inspection of the existing pavement with the following goals:

- Determine the type, severity, and extent of any pavement distress(es) and the condition of the subgrade/subbase support. (For descriptions of pavement distress types and levels of severity, see the discussion in Appendix A).
- Identify any drainage problems and potential restrictions regarding elevation and grade.
- Identify the presence of paving fabric, which could interfere with the asphalt's ability to behave as a single layer.

The visual inspection should include an identification of pavement surface distresses, core analyses, and an optional analysis of support conditions.

Identification of Pavement Surface Distresses

Asphalt pavement distress in the form of visible defects or deterioration is the most basic indication of an existing pavement's current performance and structural condition. A visual survey of pavement distress(es) determines the type, severity, and extent of any observed distress(es):

- The type of distress is determined primarily by its location and appearance and can indicate underlying causes of deterioration.
- The severity of distress represents the criticality of the distress in terms of progression; more severe distresses require more extensive rehabilitation measures.
- The extent of each distress type indicates the amount of parking lot area affected by the distress.

Using the examples in Appendix A as a guide, a thorough and detailed visual inspection of the existing parking lot should be conducted, possibly including a discussion with the owner, to identify and evaluate distresses and to discover evidence of any moisture/drainage problems. This information will be used to determine the type and extent of field testing required, if any.

One key to a successful concrete overlay is uniform support by the underlying pavement and subgrade/subbase. *Since asphalt tends to reflect underlying support problems and other defects, any deterioration in the asphalt surface course that may indicate such problems should be thoroughly investigated.* For example, if the existing pavement is a composite material (asphalt over concrete), any serious deterioration in the concrete will be reflected in the asphalt course.

Poor subgrade drainage conditions are a major cause of distress in asphalt parking lots, and distress caused by subgrade drainage problems needs to be repaired before the overlay is placed. *Unless drainage and other moisture-related problems are identified and corrected, the effectiveness of spot repairs will be reduced.* As part of the visual inspection, the overall drainage conditions should be assessed for the following:

- Moisture-related distress
- Prevailing drainage conditions (e.g., pavement slopes, intake conditions, surrounding site drainage)
- Subdrain conditions

Observations of moisture/drainage problems (e.g., pumping, standing water, and so on) can be incorporated into a visual inspection. If a subdrain is present, its effectiveness should be evaluated by observing its outflow after a rainfall. Another way to assess subdrain effectiveness is through video inspection (Daleiden 1998, Christopher 2000). A video camera attached to a pushrod cable and inserted into the drainage system at various outlets can be used to locate blockages like roots, rodents' nests, or areas of crushed pipe.

In addition to identifying distresses and assessing support and drainage conditions, the visual inspection should include consideration of the potential effects of raising the pavement elevation, particularly adjacent to the building frontage, storm intakes, and curb and gutter units (refer to Figure 6). The effect of raising the pavement grade can be minimized if the asphalt is thick enough for a portion of the existing pavement depth to be removed through milling.

Core Analyses

Core analyses can supplement information collected from the visual inspection and provide additional detail about the condition of the slab and subsurface. A 1 in. hammer drill (Figure 8) can be used to quickly determine the depth of the existing asphalt in several locations and, together with visual inspection, identify locations of potential subsurface problems where cores should be taken.

Generally, 2 to 4 in. diameter cores are taken from the asphalt and subbase, as shown in Figure 9. In the cores, the lift layers in the asphalt and the presence of paving fabric between the asphalt lifts should be noted. If paving fabric is found and the amount of asphalt above the fabric is insufficient to provide the minimum thickness for a bonded concrete overlay, an unbonded overlay might be considered.



David White, Iowa State University, used with permission

Figure 8. Hammer drilling to check pavement thickness

Cores can reveal the depth of distress(es), the pavement's support value, and the kinds/thicknesses/conditions of lift (or layer) materials. Cores that penetrate into the subgrade may show evidence of unstable conditions, such as the beginning of fine soil migration into open-graded subbase layers that can lead to plugging and instability. Cores also provide samples for further laboratory analyses, if needed.

Support conditions—defined as the ability of the subgrade/subbase to support loads uniformly throughout the pavement—affect both the design thickness of the concrete overlay and the overlay's performance. Without uniform support, the life of the overlay will be diminished. It is important, therefore, to try to obtain cores that reveal the current condition of the subgrade/subbase support (relative bearing capacity) under the asphalt.



Construction Materials Testing, used with permission

Figure 9. Typical core of asphalt parking lot with granular subbase

Without the detailed information provided by cores, problems can develop in the overlay, such as those shown in Figure 10. According to the historical records for this parking lot, the existing asphalt was 6 in. thick. However, when 3 in. of the asphalt surface was milled off to accommodate a 3 in. concrete overlay, the granular subbase was exposed in some locations, and the difference in support conditions between the asphalt and the exposed subbase was not addressed. After the concrete overlay was completed, those locations where milling had exposed the subbase failed under the weight of trucks due to nonuniform support.



Randy Riley, ACPA, IL Chapter, used with permission

Figure 10. Concrete overlay failure resulting from inadequate information about support conditions

Optional Analysis of Support Conditions

In most cases, a visual examination and core analyses provide enough information to determine whether the existing asphalt parking lot pavement is a good candidate for a concrete overlay and, if so, the appropriate overlay design. Sometimes, however, further analysis is required in areas suspected of poor support. One such analysis may include determination of the subgrade/subbase support conditions under the asphalt in terms of the California bearing ratio (CBR).

A low-cost and easy on-site method for determining the level of support in terms of CBR involves the use of the dynamic cone penetrometer (DCP), shown in Figure 11. This instrument provides a measure of the in situ strength of fine-grained and granular subgrades and granular base and subbase materials.

In addition to its usefulness in characterizing support conditions, the CBR value can also be important in terms of overlay thickness design. The method described in this guide for designing overlay thickness uses bearing capacity expressed in terms of the modulus of subgrade reaction (k). Although the k -value is difficult to measure, it can be estimated relatively easily from the CBR value.

In Table 1, CBR values are associated with k -values expressed in pounds per square inch (psi) per inch, or pounds per cubic inch (pci). In the table, general ranges of both values are associated with certain subgrade soil types and support conditions. For projects designed for light traffic loads only, or where extensive soil testing is impractical or economically unjustified considering the project scope, the k -value can be estimated. Conservatism is advised when such estimates are made.

Table 1. Subgrade soil types and approximate support values

Soil type	Support	k (psi/in.)	CBR
Fine grained; silt and clay-size particles predominate	Low	75 to 120	2.5 to 3.5
Sand and sand-gravel mixture with moderate amounts of silt and clay	Medium	130 to 170	4.5 to 7.5
Sand and sand-gravel mixture relatively free of plastic fines	High	180 to 220	8.5 to 12.0

Notes:

- 1 psi = 0.0069 MPa; 1 psi/in. = 0.27 MPa/m
2. Table based on information in ACI PRC-330-21 (ACI Committee 330 2021) regarding ranges of values for several types of subgrade soil (Portland Cement Association 1984; ACPA 1982) compacted to the specified density



David White, Iowa State University, used with permission

Figure 11. Dynamic cone penetrometer

Step 3. Complete a Pavement Evaluation Report

The information collected during the evaluation should be summarized in a pavement evaluation report. This report is utilized during the design process and can be used to complete a cost feasibility study. The report, along with the feasibility study, can be shared with the owner to justify the overlay project.

Design of Parking Lot Overlays

Bonded and Unbonded Concrete Overlays

With few or no spot repairs, asphalt parking lots that exhibit low-to medium-severity surface distresses can generally be enhanced with a bonded concrete overlay, provided that the existing pavement is relatively uniform and stable, the pavement is free of loose asphalt materials, and elevation criteria are met. Refer to Figure 1 and Appendix A for examples of low- to medium-severity distresses in asphalt pavements.

A bonded concrete overlay relies on the existing asphalt to carry some traffic loading, and its performance very much depends on the condition of the existing asphalt pavement. For this reason, it is particularly important to characterize the existing asphalt pavement's cross section and its condition in terms of the type, severity, and extent of distresses. Because the overlay bonds to the existing asphalt to form a monolithic pavement structure, the existing asphalt must contribute a certain level of strength and integrity and be capable of forming and maintaining a bond with the overlay. If these conditions are met, the overlaid pavement system will experience reduced stresses and deflections. The formation of a monolithic pavement structure also allows bonded overlays to be thinner than unbonded overlays.

Maintaining the bond is especially critical during the first few days after placement, when the overlay is susceptible to curling and warping stresses, especially at the pavement edges. Therefore, the bond must be protected through thorough curing practices and by keeping early traffic away from the pavement edges until adequate bond strength is achieved (usually when opening strength has been achieved).

For asphalt parking lot pavements with high-severity distresses, an unbonded overlay is generally an appropriate solution, provided that the subgrade/subbase is stable and elevation criteria are met. Refer to Figure 2 and Appendix A for examples of high-severity distresses in asphalt pavements.

For an unbonded concrete overlay, the existing asphalt parking lot serves as a subbase or foundation for the new pavement and typically offers greater structural capacity than traditional subgrade materials. If the observed high-severity distresses are caused by a wet and/or spongy subbase or subgrade that is moving and unstable throughout significant areas of the parking lot, the subgrade or subbase must be stabilized before the new pavement is placed.

Figure 12 presents a flowchart to assist in the decision to select a bonded or unbonded concrete overlay for a given scenario.

Overlay Thickness Design

The condition of the existing pavement and the traffic loading are the paramount factors when selecting the thickness of the concrete overlay. When the existing asphalt pavement has high-severity distresses, a thicker concrete overlay can be considered.

Thickness Design for Bonded Concrete Overlays

One of the more challenging aspects of designing the thickness of bonded overlays on asphalt is the consideration of the supporting platform. For concrete overlays of asphalt pavement, the modulus of subgrade reaction, or k -value, described earlier, is based on the subbase/subgrade value under the asphalt layer. The asphalt itself is not considered in the k -value because the asphalt becomes part of the new monolithic pavement thickness when concrete is bonded to it.

The k -value is needed when determining the value of the support structure under the existing asphalt pavement. Table 3.4 from ACI PRC-330-21 (ACI Committee 330 2021) presents k -values for typical subgrade soils.

In addition to the need to characterize the supporting platform, a unique design consideration for bonded overlays on asphalt pavements is the joint spacing required to mitigate curling and warping stresses in the overlay. The joint spacing is affected by the thickness of the underlying asphalt and the thickness and flexural strength of the concrete overlay. The recommended joint pattern for bonded concrete overlays of asphalt is small squares, typically in the range of 4 to 6 ft (or 12 to 18 times the thickness in inches). Figure 13 shows a concrete overlay of an asphalt parking lot with 4 ft by 4 ft panels.

For this guide, the ACPA's BCOA Thickness Designer software (available at <http://apps.acpa.org/applibrary/BCOA/>) has been used to determine overlay design thicknesses for light-vehicle asphalt parking lots.

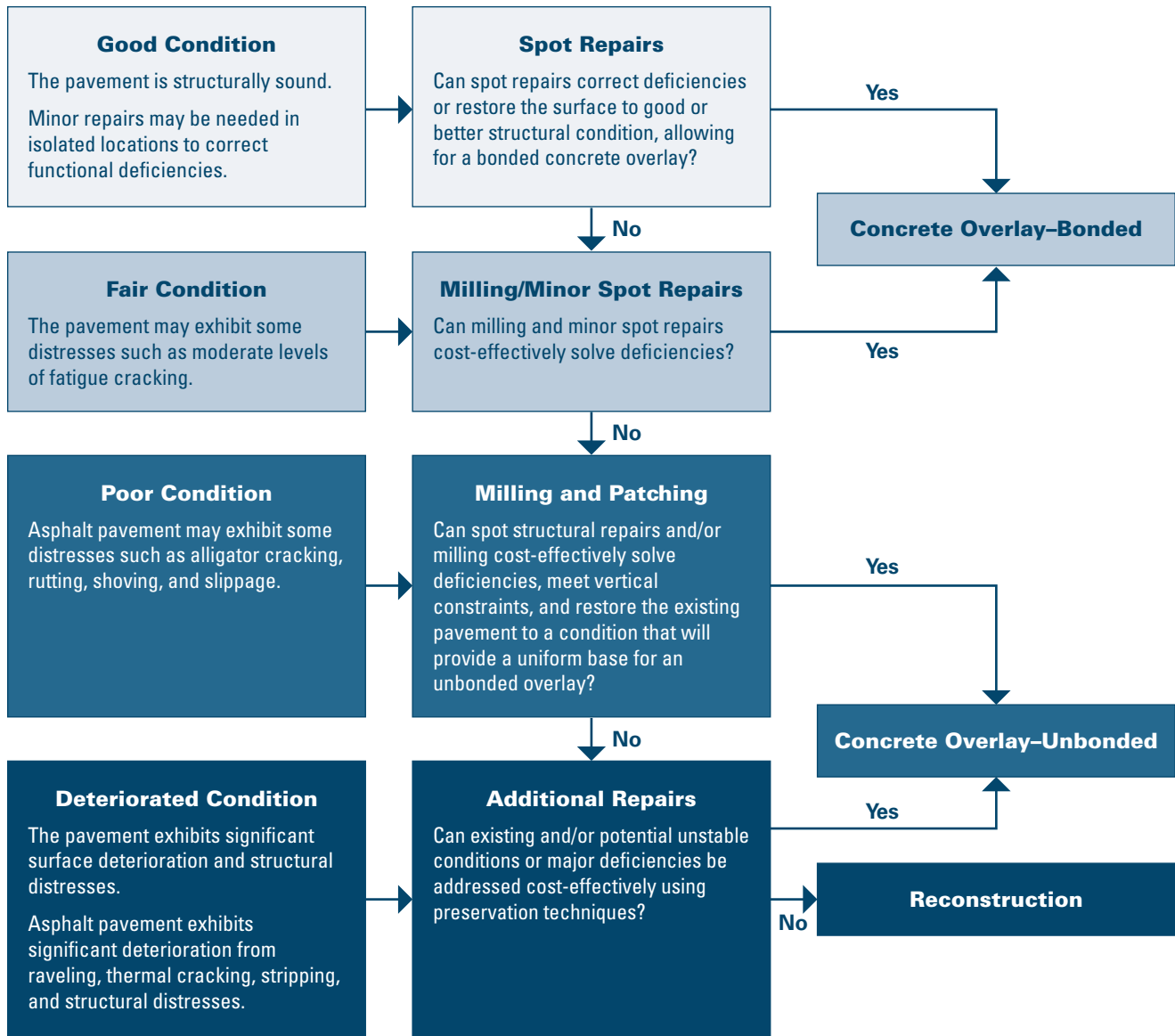

CP Tech Center

Figure 12. Flowchart for selecting a bonded or unbonded concrete overlay

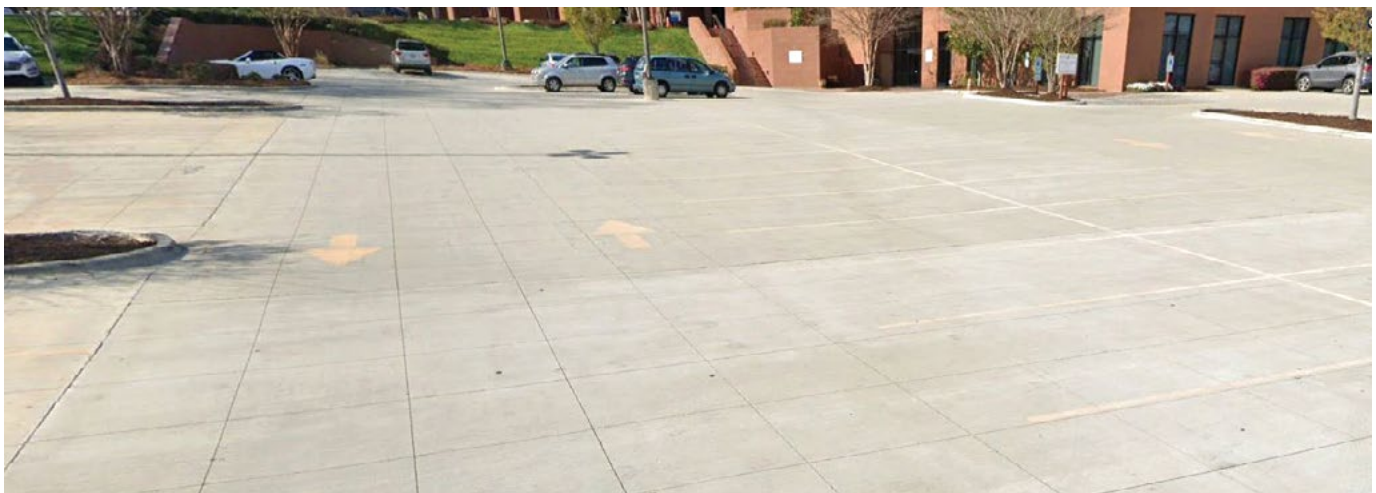

Snyder & Associates, Inc., used with permission

Figure 13. Concrete overlay of asphalt parking lot with 4 ft by 4 ft panels

This web application is based primarily on the results of FHWA-ICT-08-016, *Design and Concrete Material Requirements for Ultra-Thin Whitetopping* (Roesler et al. 2008), a research project conducted in cooperation with the Illinois Center for Transportation at the University of Illinois (ICT), the Illinois Department of Transportation (IDOT), and the Federal Highway Administration (FHWA). The method underlying the BCOA Thickness Designer tool allows for the input of existing asphalt pavement properties, including the existing asphalt's remaining modulus of elasticity; accounts for structural fibers; and checks for a potential bond plane failure.

The inputs for the ACPA's BCOA Thickness Designer tool include the following:

- Equivalent design lane single axle loads (ESALs)
- Percentage of allowable cracked slabs at end of design life
- Reliability
- Effective temperature gradient and corresponding percentage time
- City, state
- Existing pavement structure:
 - Remaining asphalt thickness and modulus
 - k -value of subgrade/subbase
- Concrete overlay:
 - Flexural strength, modulus, and coefficient of thermal expansion (CTE) based on coarse aggregate type
 - Fiber type and residual strength ratio
 - Proposed joint spacing and pre-overlay surface preparation

It should be noted that while the modified design method used in the ACPA's current BCOA Thickness Designer tool is suitable for designing bonded concrete overlays over asphalt parking lots, revisions to the software are ongoing. Future updates will enhance some of the models and provide default inputs that will streamline the design process for locations throughout the United States.

Specifically, it is important to note that though this tool currently offers the ability to consider project-specific temperature gradient inputs, such information may not be readily available to pavement designers. The current default values in BCOA Thickness Designer for the effective temperature gradient and the percentage time at the effective temperature gradient were developed by Roesler et al. (2008) based on field data for the state of Illinois. Since then, Feng and Vandenbossche (2012) have defined an equivalent temperature gradient based on the solar radiation present at the geographical location of a given project within the United States.

This work has been incorporated into a similar design procedure, the University of Pittsburgh's BCOA-ME. The BCOA-ME software also determines concrete overlay thickness based on input variables similar to those used by the ACPA's BCOA Thickness Designer tool. However, BCOA-ME offers more defined input variables, including climate, exact geographic location, concrete fiber type and dosage, and the properties and condition of the existing asphalt.

PavementDesigner.org (<https://www.pavementdesigner.org/>) is another design procedure that can be used to design concrete parking lots, streets, and industrial intermodal facilities. If the option for designing a bonded overlay is selected, the program defaults to the University of Pittsburgh's BCOA-ME design procedure.

Thickness Design for Unbonded Concrete Overlays

When an asphalt parking lot exhibits high-severity distresses, it is recommended that an unbonded concrete overlay be constructed in lieu of a bonded concrete overlay.

Table 2 lists the minimum thicknesses for an unbonded concrete overlay based on the existing condition of the underlying pavement (base) and future loadings. These thicknesses are based on calculated stresses and fatigue resistance values from the Portland Cement Association's (PCA's) design procedure (Packard 1984). The thicknesses are rounded to the nearest ½ in.

For the thickness design of unbonded concrete overlays of parking lots with light vehicle traffic (cars and pickup trucks with little or no truck traffic), the preferred approach is to follow the design thicknesses in Table 2 and the design recommendations in ACI PRC-330-21 (ACI Committee 330 2021).

Table 2. Design thicknesses for unbonded concrete overlays

MOR/psi	$k = 50$ psi/in. (CBR = 2)		$k = 100$ psi/in. (CBR = 3)		$k = 200$ psi/in. (CBR = 10)	
	600	650	600	650	600	650
A (ADTT = 1)	5.0	4.5	4.5	4.0	4.0	4.0
A (ADTT = 10)	5.5	5.0	5.0	4.5	4.5	4.5
B (ADTT = 25)	6.0	6.0	5.5	5.5	5.0	5.0

Notes:

1. 20-year design thickness recommendations, in inches (no dowels)
2. ADTT = average daily truck traffic (vehicles with at least six wheels, excluding panel trucks)
3. MOR = modulus of rupture
4. k = modulus of subgrade reaction (psi/in.) for all materials below the new concrete pavement

Use of Fibers

The use of fibers in concrete overlays of asphalt parking lots is beneficial in the following circumstances:

- Vertical restrictions limit the overlay thickness.
- Heavier-weight traffic loads are expected.
- Increased joint spacing is desirable.

If the parking lot only serves light vehicles (cars and pickup trucks) and the above circumstances do not apply to the project, then the use of fibers is typically not necessary.

Though steel fibers have a long history in paving applications, synthetic fibers (Figure 14) have become predominant in the last two decades due to their ease of handling, better dispersion characteristics (i.e., less “balling”), and resistance to rust damage.



Sherry Sullivan, FORTA, used with permission

Figure 14. Concrete mix containing synthetic fibers

Whether steel or synthetic fibers are used, the volume of fibers in a concrete mixture is expressed as a percentage of the total volume of the composite (concrete and fibers). The exact dosage is specified to produce certain behavior characteristics in the concrete.

In appropriate dosages, fibers can perform the following functions in a concrete mixture:

- Increase concrete toughness (allowing thinner concrete slabs and/or longer joint spacing)
- Control differential slab movement caused by curling/warping, heavy loads, temperatures, and so on (allowing longer joint spacing)
- Hold cracks tightly together (enhancing aesthetics and concrete performance)
- Increase concrete resistance to plastic shrinkage cracking (enhancing aesthetics and concrete performance)

Table 3 provides a summary of current categories of fibers, with general descriptions and application rates. For a more detailed discussion of fibers, refer to Appendix B.

Table 3. Summary of fiber types

Fiber type	Size (D = equivalent diameter, L = length)	Years used in US (as of 2021)	Typical rate (lb/yd ³)	Comments
Synthetic microfiber	D < 0.012 in. L 0.50 to 2.25 in.	35	1.0 to 3.0	Reduces plastic shrinkage cracking and settlement cracking; limited effect on overall concrete overlay performance; more workability issues when using higher rates
Synthetic macrofiber	D > 0.012 in. L 1.50 to 2.25 in.	20	3.0 to 7.5	Increases post-crack flexural performance, fatigue-impact endurance; thinner concrete thickness; longer joint spacing; tighter joints and tighter cracks
Steel macrofiber (carbon)	L 0.75 to 2.50 in.	40	33 to 100	Increases strain strength, impact resistance, post-crack flexural performance, fatigue endurance, crack width control, per ACI 544.4R
Blended	Varies	15	Varies	Blend of small dosage of synthetic microfibers and larger dosage of either synthetic macrofibers or steel macrofibers

Synthetic (polymer) fiber materials:

- Polypropylene
 - Monofilament (cylindrical): Fibers of same length
 - Multifilament: Monofilament fibers of different lengths
 - Fibrillated (rectangular): Net-shaped fiber collated in interconnected clips
- Polyester
- Nylon

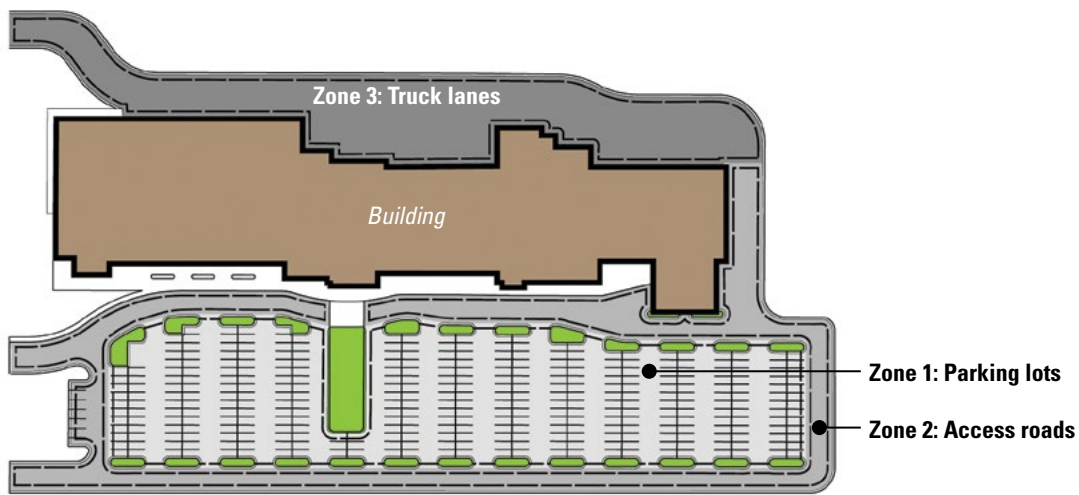

Recreated from Snyder & Associates, Inc., used with permission

Figure 15. Parking lot with three designated design zones

Zone Design for Parking Lot Overlays

When different sections of an asphalt parking lot have significantly different traffic loadings, the concrete overlay of that parking lot can and should be designed in separate sections or zones. For example, parking lot areas with light traffic (cars or pickup trucks) may allow reduced overlay thicknesses, while access ways and truck lanes, such as those used for delivery routes, may require thicker overlays. Figure 15 shows a typical parking lot layout with three different zones that should be designed separately. Note that not all parking lots have all three zones.

On the following pages, Tables 4 through 6 list common design thicknesses for the majority of concrete overlays on existing asphalt parking lots. Each table is divided into three sections, one for each of the three parking lot zones identified in Figure 15.

The overlay design thicknesses were developed using the ACPA's modified BCOA Thickness Designer program, described earlier, and are based on information in FHWA-ICT-08-016, *Design and Concrete Material Requirements for Ultra-Thin Whitetopping* (Roesler et al. 2008). The following design assumptions were used:

- 20-year design life
- 50 percent directional distribution factor
- 75 percent design lane distribution factor
- 2 percent growth rate
- 30 percent cracked slabs at end of design life
- 80 percent reliability

- 300,000 psi asphalt modulus of elasticity
- 100 pci k -value of the subgrade (under the asphalt)
- 25 percent residual strength ratio (with fibers)
- 3,600,000 psi concrete modulus of elasticity
- Pre-overlay surface preparation: existing asphalt is cleaned only (not milled)
- Coefficient of thermal expansion based on limestone
- Thickness values rounded up to the nearest 0.5 in.

Note that Tables 4 through 6 are to be used for general reference purposes only. For design purposes, actual overlay thicknesses should be determined based on specific design variables for the project using the ACPA's BCOA Thickness Designer program.

The three tables provide overlay thicknesses for three geographical areas in the United States with different mean annual daily temperatures (MADT). Table 4 represents an MADT of 45°F to 50°F (e.g., Des Moines, Iowa), Table 5 an MADT of 55°F to 60°F (e.g., Sacramento, California), and Table 6 an MADT of 65°F to 70°F (e.g., Gainesville, Florida). Some areas in the country have lower MADTs (e.g., North Dakota with 32°F to 40°F) or higher MADTs (e.g., Arizona with 70°F or higher). Therefore, when the BCOA Thickness Designer program is used for any specific overlay project, the designer should enter the major city closest to the project site when prompted for the location; the program will automatically account for the correct MADT in the thickness design.

In developing Tables 4 through 6, several iterations of the BCOA Thickness Designer program were run to determine trends in overlay thickness design by varying the joint spacing, the use of macrofibers, concrete flexural strength, existing asphalt thickness, and traffic loads.

The following general trends were observed:

- A higher aggregate coefficient of thermal expansion increases the required concrete overlay thickness. A change from limestone (4.34×10^{-6} in./in./°F) to chert (6.01×10^{-6} in./in./°F) increases the overlay thickness by up to 0.5 in.
- The k -value has minimal effect on the concrete thickness based on k -values of 50, 100, and 200 pci.

For Tables 4 through 6, the relationship between concrete compressive strength and concrete flexural strength is based on Yoder and Witzak (1975). Other conversions can be determined using the ACPA Strength Converter at the following link: <http://apps.acpa.org/applibrary/StrengthConverter/>.

For a detailed understanding of the residual strength property that macrofibers provide, the Residual Strength Estimator program developed by Bordelon and Roesler (2019) can be used. This program can be downloaded at the following link: https://intrans.iastate.edu/app/uploads/2019/03/Residual-Strength-Estimator-for-FRC-Overlays-April-19-2019_public.xlsx.

Special Design Considerations for Two-Inch-Thick Concrete Overlays

Although 2 in. thick concrete overlays of asphalt parking lots have been successful, their design and construction do require special attention. Figure 16 shows a 2 in. thick concrete overlay of an existing 2.5 in. thick asphalt parking lot on 6 to 8 in. of stone subbase. The concrete overlay was approximately 8 years old in the photo.



Randy Riley, ACPA, IL Chapter, used with permission

Figure 16. Two-inch-thick concrete overlay

A notable feature of this type of overlay is short joint spacing, which allows the concrete overlay to deflect instead of bend and can thereby reduce load stresses in the concrete slab to reasonable values, even at thicknesses as low as 2 in. The short joint spacing also addresses the differential thermal movement between the asphalt and concrete and reduces curling and warping stresses in the concrete overlay.

Some computer programs, such as the ACPA's BCOA Thickness Designer and the University of Pittsburgh BCOA-ME, use a minimum overlay design thickness of 3 in. Other programs, such as the American Association of State Highway and Transportation Officials' AASHTOWare Pavement ME Design (AASHTO 2021) and the National Ready Mixed Concrete Association's (NRMCA's) Concrete Pavement Analyst (NRMCA n.d.), use a minimum thickness of 4 in. Therefore, a 2 in. thickness cannot readily be calculated using existing software, although a 2 in. thickness design is possible using charts and tables of the different overlay methods.

Asphalt parking lots in need of increased structural capacity can be candidates for 2 in. bonded concrete overlays if the following conditions can be met:

- The area is strictly limited to cars and other light vehicles.
- The existing asphalt pavement is at least 4 in. thick and has low- to medium-severity distress.
- The modulus of subgrade reaction (k) is 100 psi/in. or greater, or the CBR value is 3 or greater.
- A minimum thickness of 2.5 in. of asphalt—and preferably more—remains after milling.
- The concrete overlay includes macrofibers. High-volume synthetic macrofibers are typically used in concrete overlays at a rate of 4 lb/yd³. It should be noted that different manufacturers may recommend differing dosage rates based on the material's residual strength property.
- The flexural strength of the concrete overlay is 700 psi at 28 days based on third-point loading.
- A maximum 3 ft by 3 ft joint spacing is used.

Table 4. Typical bonded concrete overlay thickness over asphalt where mean annual daily temperatures are 45°F to 50°F (e.g., Des Moines, Iowa)

Zone 1: Parking lot area (≤200 light vehicles/day and ≤1 truck [0.32 ESAL/truck]/day)							
Existing asphalt thickness (in.)	Concrete compressive strength (psi) / flexural strength (psi) (third point)	4 ft joint spacing	5 ft joint spacing	6 ft joint spacing	4 ft joint spacing	5 ft joint spacing	6 ft joint spacing
		Thickness (in.) (no fiber)			Thickness (in.) (with fiber)		
2.0	4,000 / 630	4.0	4.5	5.0	3.5	3.5	4.0
2.0	4,500 / 670	4.0	4.5	4.5	3.0	3.5	4.0
3.0	4,000 / 630	3.5	4.0	4.5	3.0	3.0	3.5
3.0	4,500 / 670	3.5	4.0	4.5	3.0	3.0	3.5
4.0	4,000 / 630	3.0	3.5	4.0	3.0	3.0	3.0
4.0	4,500 / 670	3.0	3.5	4.0	3.0	3.0	3.0
6.0	4,000 / 630	3.0	3.0	3.0	3.0	3.0	3.0
6.0	4,500 / 670	3.0	3.0	3.0	3.0	3.0	3.0
Zone 2: Access road (≤1,000 light vehicles/day and ≤10 trucks [0.35 ESAL/truck]/day)							
Existing asphalt thickness (in.)	Concrete compressive strength (psi) / flexural strength (psi) (third point)	4 ft joint spacing	5 ft joint spacing	6 ft joint spacing	4 ft joint spacing	5 ft joint spacing	6 ft joint spacing
		Thickness (in.) (no fiber)			Thickness (in.) (with fiber)		
2.0	4,000 / 630	5.0	5.5	6.0	3.5	4.0	4.5
2.0	4,500 / 670	4.5	5.0	5.5	3.5	4.0	4.5
3.0	4,000 / 630	4.5	5.0	5.5	3.5	4.0	4.0
3.0	4,500 / 670	4.0	4.5	5.0	3.0	3.5	4.0
4.0	4,000 / 630	3.5	4.5	5.0	3.0	3.0	3.5
4.0	4,500 / 670	3.5	4.0	4.5	3.0	3.0	3.5
6.0	4,000 / 630	3.0*	3.0*	3.0*	3.0	3.0	3.0
6.0	4,500 / 670	3.0*	3.0*	3.0*	3.0	3.0	3.0
Zone 3: Truck lane (≤1,000 light vehicles/day and ≤25 trucks [0.600 ESAL/truck]/day)							
Existing asphalt thickness (in.)	Concrete compressive strength (psi) / flexural strength (psi) (third point)	4 ft joint spacing	5 ft joint spacing	6 ft joint spacing	4 ft joint spacing	5 ft joint spacing	6 ft joint spacing
		Thickness (in.) (no fiber)			Thickness (in.) (with fiber)		
2.0	4,000 / 630	5.5	6.0	6.0	4.0	4.5	5.0
2.0	4,500 / 670	5.0	5.5	6.0	4.0	4.0	4.5
3.0	4,000 / 630	5.0	6.0	6.0	3.5	4.0	4.5
3.0	4,500 / 670	4.5	5.0	6.0	3.5	4.0	4.0
4.0	4,000 / 630	4.0	5.0	6.0	3.0	3.5	4.0
4.0	4,500 / 670	4.0	4.5	5.0	3.0	3.0	3.5
6.0	4,000 / 630	3.0*	3.0*	4.0	3.0	3.0	3.0
6.0	4,500 / 670	3.0*	3.0*	3.0*	3.0	3.0	3.0

Notes: k-value = 100 pci (or 100 psi/in.) (for the area below the existing asphalt and representing the value of the subgrade/subbase)

* = low-severity asphalt distress

Table 5. Typical bonded concrete overlay thickness over asphalt where mean annual daily temperatures are 55°F to 60°F (e.g., Sacramento, California)

Zone 1: Parking lot area (≤200 light vehicles/day and ≤1 truck [0.32 ESAL/truck]/day)							
Existing asphalt thickness (in.)	Concrete compressive strength (psi) / flexural strength (psi) (third point)	4 ft joint spacing	5 ft joint spacing	6 ft joint spacing	4 ft joint spacing	5 ft joint spacing	6 ft joint spacing
		Thickness (in.) (no fiber)			Thickness (in.) (with fiber)		
2.0	4,000 / 630	4.5	5.0	5.5	3.5	4.0	4.0
2.0	4,500 / 670	4.0	4.5	5.0	3.5	3.5	4.0
3.0	4,000 / 630	4.0	4.5	5.0	3.0	3.5	3.5
3.0	4,500 / 670	4.0	4.5	5.0	3.0	3.5	3.5
4.0	4,000 / 630	3.5	4.0	4.5	3.0	3.0	3.0
4.0	4,500 / 670	3.0	3.5	4.5	3.0	3.0	3.0
6.0	4,000 / 630	3.0	3.0	3.0	3.0	3.0	3.0
6.0	4,500 / 670	3.0	3.0	3.0	3.0	3.0	3.0
Zone 2: Access road (≤1,000 light vehicles/day and ≤10 trucks [0.35 ESAL/truck]/day)							
Existing asphalt thickness (in.)	Concrete compressive strength (psi) / flexural strength (psi) (third point)	4 ft joint spacing	5 ft joint spacing	6 ft joint spacing	4 ft joint spacing	5 ft joint spacing	6 ft joint spacing
		Thickness (in.) (no fiber)			Thickness (in.) (with fiber)		
2.0	4,000 / 630	5.5	6.0	6.0	4.0	4.5	5.0
2.0	4,500 / 670	5.0	6.0	6.0	4.0	4.0	4.5
3.0	4,000 / 630	5.0	6.0	6.0	3.5	4.0	4.5
3.0	4,500 / 670	4.5	5.5	6.0	3.5	4.0	4.5
4.0	4,000 / 630	4.5	5.5	6.0	3.0	3.5	4.0
4.0	4,500 / 670	4.0	5.0	5.5	3.0	3.0	3.5
6.0	4,000 / 630	3.0*	3.5	4.5	3.0	3.0	3.0
6.0	4,500 / 670	3.0*	3.0*	3.5	3.0	3.0	3.0
Zone 3: Truck lane (≤1,000 light vehicles/day and ≤25 trucks [0.600 ESAL/truck]/day)							
Existing asphalt thickness (in.)	Concrete compressive strength (psi) / flexural strength (psi) (third point)	4 ft joint spacing	5 ft joint spacing	6 ft joint spacing	4 ft joint spacing	5 ft joint spacing	6 ft joint spacing
		Thickness (in.) (no fiber)			Thickness (in.) (with fiber)		
2.0	4,000 / 630	6.0	6.0	6.0	4.5	5.0	5.5
2.0	4,500 / 670	6.0	6.0	6.0	4.0	4.5	5.0
3.0	4,000 / 630	6.0	6.0	6.0	4.0	4.5	5.0
3.0	4,500 / 670	5.5	6.0	6.0	3.5	4.0	4.5
4.0	4,000 / 630	5.5	6.0	6.0	3.5	4.0	4.5
4.0	4,500 / 670	5.0	6.0	6.0	3.0	3.5	4.0
6.0	4,000 / 630	3.0*	4.5	6.0	3.0	3.0	3.0
6.0	4,500 / 670	3.0*	3.5	4.5	3.0	3.0	3.0

Notes: k-value = 100 pci (or 100 psi/in.) (for the area below the existing asphalt and representing the value of the subgrade/subbase)

* = low-severity asphalt distress

Table 6. Typical bonded concrete overlay thickness over asphalt where mean annual daily temperatures are 65°F to 70°F (e.g., Gainesville, Florida)

Zone 1: Parking lot area (≤200 light vehicles/day and ≤1 truck [0.32 ESAL/truck]/day)							
Existing asphalt thickness (in.)	Concrete compressive strength (psi) / flexural strength (psi) (third point)	4 ft joint spacing	5 ft joint spacing	6 ft joint spacing	4 ft joint spacing	5 ft joint spacing	6 ft joint spacing
		Thickness (in.) (no fiber)			Thickness (in.) (with fiber)		
2.0	4,000 / 630	4.5	5.0	5.0	3.5	4.0	4.0
2.0	4,500 / 670	4.0	4.5	5.0	3.0	3.5	4.0
3.0	4,000 / 630	4.0	4.5	5.0	3.0	3.5	3.5
3.0	4,500 / 670	3.5	4.0	4.5	3.0	3.0	3.5
4.0	4,000 / 630	3.0	4.0	4.5	3.0	3.0	3.0
4.0	4,500 / 670	3.0	3.5	4.0	3.0	3.0	3.0
6.0	4,000 / 630	3.0	3.0	3.0	3.0	3.0	3.0
6.0	4,500 / 670	3.0	3.0	3.0	3.0	3.0	3.0
Zone 2: Access road (≤1,000 light vehicles/day and ≤10 trucks [0.35 ESAL/truck]/day)							
Existing asphalt thickness (in.)	Concrete compressive strength (psi) / flexural strength (psi) (third point)	4 ft joint spacing	5 ft joint spacing	6 ft joint spacing	4 ft joint spacing	5 ft joint spacing	6 ft joint spacing
		Thickness (in.) (no fiber)			Thickness (in.) (with fiber)		
2.0	4,000 / 630	5.0	6.0	6.0	4.0	4.5	4.5
2.0	4,500 / 670	4.5	5.5	6.0	3.5	4.0	4.5
3.0	4,000 / 630	4.5	5.5	6.0	3.5	4.0	4.5
3.0	4,500 / 670	4.5	5.0	5.5	3.0	3.5	4.0
4.0	4,000 / 630	4.0	5.0	5.5	3.0	3.0	3.5
4.0	4,500 / 670	3.5	4.5	5.0	3.0	3.0	3.5
6.0	4,000 / 630	3.0*	3.0*	3.5	3.0	3.0	3.0
6.0	4,500 / 670	3.0*	3.0*	3.0*	3.0	3.0	3.0
Zone 3: Truck lane (≤1,000 light vehicles/day and ≤25 trucks [0.600 ESAL/truck]/day)							
Existing asphalt thickness (in.)	Concrete compressive strength (psi) / flexural strength (psi) (third point)	4 ft joint spacing	5 ft joint spacing	6 ft joint spacing	4 ft joint spacing	5 ft joint spacing	6 ft joint spacing
		Thickness (in.) (no fiber)			Thickness (in.) (with fiber)		
2.0	4,000 / 630	6.0	6.0	6.0	4.0	4.5	5.0
2.0	4,500 / 670	5.0	6.0	6.0	4.0	4.5	4.5
3.0	4,000 / 630	5.5	6.0	6.0	3.5	4.0	4.5
3.0	4,500 / 670	5.0	5.5	6.0	3.5	4.0	4.5
4.0	4,000 / 630	4.5	5.5	6.0	3.0	3.5	4.0
4.0	4,500 / 670	4.0	5.0	5.5	3.0	3.5	4.0
6.0	4,000 / 630	3.0*	3.5	4.5	3.0	3.0	3.0
6.0	4,500 / 670	3.0*	3.0*	3.5	3.0	3.0	3.0

Notes: k-value = 100 pci (or 100 psi/in.) (for the area below the existing asphalt and representing the value of the subgrade/subbase)

* = low-severity asphalt distress

Jointing for Parking Lot Overlays

Joints are placed in concrete pavements to minimize random cracking and facilitate construction. Although the jointing layout for a concrete pavement should be provided as part of the construction documents, the contractor sometimes suggests alternate jointing layouts, which should be reviewed and approved by the engineer and/or designer.

The three types of joints that are commonly used in concrete pavement are contraction joints, construction joints, and isolation joints. In parking areas, the use of isolation joints should be limited to locations that isolate a structure, embedment, or existing pavement from the new pavement. With the designer's approval, construction joint details and contraction joint details

can be interchanged to suit the contractor's method of construction and placement schedule.

Figure 17 illustrates an example jointing layout for a parking lot.

The recommended joint pattern for bonded overlays of asphalt is small, square panels, typically in the range of 4 to 6 ft. This jointing design helps reduce curling and warping stresses in the concrete as well as differential movements of the concrete overlay and the asphalt. It is normally recommended that the length and width of joint squares in feet be limited to 1.5 times the overlay thickness in inches.

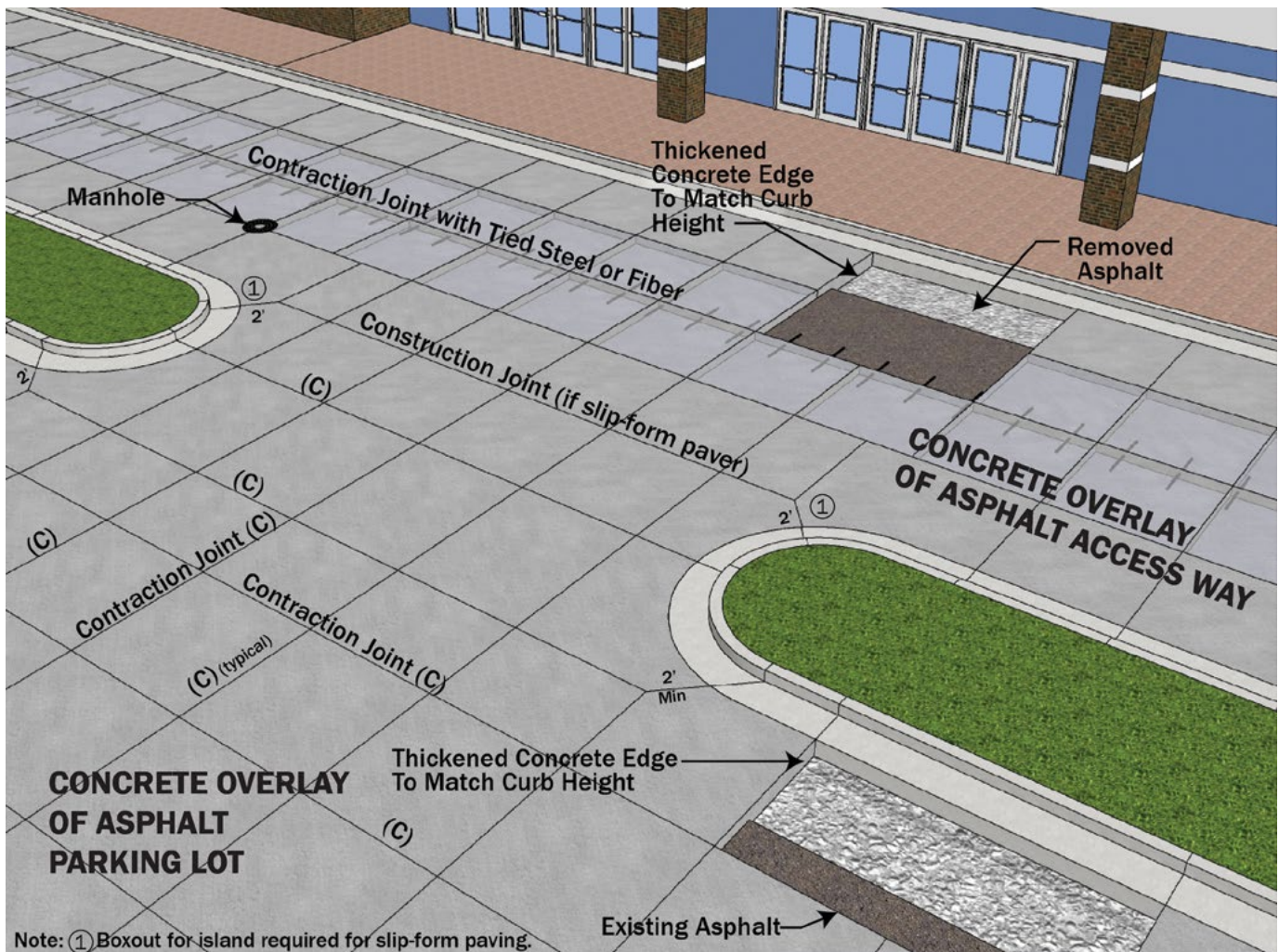

Snyder & Associates, Inc., used with permission

Figure 17. Example jointing layout for a parking lot

As is often the case in parking lots, accommodations have to be made for fixed objects. The intent in such accommodations is to maintain the nominal specified joint spacing while permitting gradual joint spacing adjustments of up to +/-10 percent in the last two or three panels adjacent to the fixed point. In parking lot areas that are expected to experience significant heavy-truck traffic, it is better to decrease the joint spacing, if possible, in the last two or three panels adjacent to the fixed point to prevent an increased potential for corner breaks. In addition, if possible, any longitudinal contraction joints in access roads or truck lanes should be arranged so that they are not in the wheel paths.

Joints must be cut as quickly as possible to minimize the development of curling stresses that trigger delamination at the pavement edges. Early-entry saws are usually used.

Except in access ways or truck lanes where the overlay thickness is 5 in. or greater, the use of tie bars in parking lots for light vehicles is not necessary because of the small panel spacings. Dowels are necessary only in construction joints and contraction joints in access ways or truck lanes with traffic heavier than automobiles or pickup trucks and with pavement thicknesses of 7 in. or more.

Contraction Joints

A contraction joint predetermines the location of cracks caused by restrained shrinkage of the concrete and by the effects of loads and warping or curling. Contraction joints create planes of weakness that subsequently produce cracks as the concrete shrinks. The planes of weakness are usually formed by sawing a continuous slot in the pavement surface. Plastic or metal inserts have been used with less-than-satisfactory results and are not recommended for creating a contraction joint in any pavement subject to wheeled traffic. The concrete should be sawcut as soon as it has hardened enough to support the saws and not ravel during sawing.

The depth of the joint should be at least one-quarter of the slab thickness when using a conventional saw or 1 to 1½ in. when using an early-entry saw. Refer to Chapter 6 of *Integrated Materials and Construction Practices for Concrete Pavement: A State-of-the-Practice Manual* (IMCP manual) for more information on early-entry saw depths (Taylor et al. 2019). The width of a cut depends on whether the joint is to be sealed. A narrow joint width, generally ¼ to ⅜ in. wide, is common for unsealed joints. Cuts at least ¼ in. wide are required for sealed joints, and ⅜ in. wide cuts are commonly recommended.

Construction Joints

Construction joints provide an interface between areas of concrete placed at different times during the course of a project. Butt-type joints without special load-transfer features are usually adequate for parking lots serving light vehicles. Keyed joints should be avoided in concrete overlays regardless of the load. Keyed joints can lose contact between the keys when the joint opens due to drying shrinkage, eventually causing a breakdown of the joint edges and failure of the top of the key.

Isolation Joints

Where concrete overlays of different thicknesses come together, such as between vehicle parking areas and truck lanes or access ways, an isolation joint needs to be placed to allow movement between the slabs. Additionally, concrete slabs should be separated from fixed objects and the abutting paved area to offset the effects of expected differential horizontal and longitudinal movements. Isolation joints are not recommended along the face of curb and gutter units abutting the pavement. Pavement joints of any type that intersect this junction should extend through the curb and gutter system. Isolation joints are not needed to accommodate expansion when contraction joints are properly spaced.

Raising Existing Curb and Gutter Systems

One feature that frequently distinguishes parking lot overlay applications from roadway overlay applications is the presence of an existing concrete curb and gutter system. In parking lots, curb and gutter systems may serve a variety of purposes in addition to drainage, such as separating parking zones, creating decorative medians complete with trees and plantings, acting as vehicle “bumper blocks,” and/or delineating the perimeter of the facility.

Frequently, accommodating fixed elevation points such as those needed for curb and gutter systems is the most challenging parking lot overlay design and construction issue, even more so than determining the design thickness. The contractor must consider necessary adjustments to attain or retain Americans with Disabilities Act–compliant ramps and sidewalks, for example, and to retain or enhance drainage.

Construction Considerations

A new curb and gutter system is not necessarily required. The curb can be milled, or it is usually possible and relatively easy to “cap” the curb. The new cap is frequently placed by hand (Figure 18) to accommodate local anomalies and irregularities. Small slipform paving machines can be used if sufficient quantities of curb and gutter units exist to warrant their use (Figure 19). With certain equipment, the existing curb can be used for grade and elevation control. The ends can be feathered to near-zero thickness, or short full-depth end sections may be recast depending on the grades and other controlling elevation points.



Amy Brooks, Castle Rock Construction Company, used with permission

Figure 18. Hand placement of a curb and gutter unit

Because concrete overlays of existing concrete curb and gutter systems are bonded concrete-on-concrete solutions, it is important that the existing curb and gutter system be prepared to promote bonding. Extensive testing over many years has revealed that the best bond is usually obtained on a surface that is clean and effectively dry. Simple water blasting or, in rare instances, sand blasting is adequate to remove dirt and provide a clean surface. (Occasionally, depending on the type and age of pavement marking material used, a concrete overlay will not bond to a painted curb. A few paint stripes are generally not an issue, but a completely painted curb should be sand blasted clean of paint.) A surface that is on the dry side of saturated surface dry is optimum, but this condition can be difficult to establish during typical field operations.

If the existing surface is adequately clean and dry, a typical ready mixed concrete mixture contains sufficient free mortar to ensure that the overlay will adhere without further preparation or the use of a bonding agent. The mixture itself can be the same as that used for the parking lot, or it can be a mixture using a smaller maximum aggregate size if better finishing characteristics are desired; this may be the case given the relatively small volume of concrete used per linear foot of curb.



Randy Riley, ACPA, IL Chapter, used with permission

Figure 19. Completed curb section

Curing

A curing compound that meets the requirements for use in conventional concrete paving should be applied on all exposed fresh concrete, both on the front face and back of the curb. Normal application rates are fine. Care should be taken to prevent or minimize overspray onto adjacent curb sections and onto adjacent asphalt pavement yet to be overlaid; the compound could interfere with the concrete-on-concrete and concrete-on-asphalt bonding, respectively.

Jointing

A few jointing details are important for constructing concrete overlays on existing concrete curb and gutter systems.

At curb and gutter areas, the overlay joints must match the locations of the existing joints and be sawed through the new curbs. If the existing joints are not matched where new concrete is placed directly on the existing concrete curb and gutter, there is a risk of random reflective cracking in the concrete overlay. Figure 20 shows a mid-panel crack located directly above a joint in the existing concrete curb and gutter.

Whether joints are sawcut or tooled is a matter of aesthetics and cost, but the owner and contractor should agree on the jointing method before the overlay is constructed.

Tight cracks in the existing curb and/or gutter that are not showing signs of faulting, widening, or spalling may be overlaid, as long as the owner understands that such cracks will eventually reflect through the overlaid section.

If the owner wants straight joints, it will be necessary to cut out a portion of the existing curb and replace it monolithically at the time of overlay construction or separately before or after overlay construction.

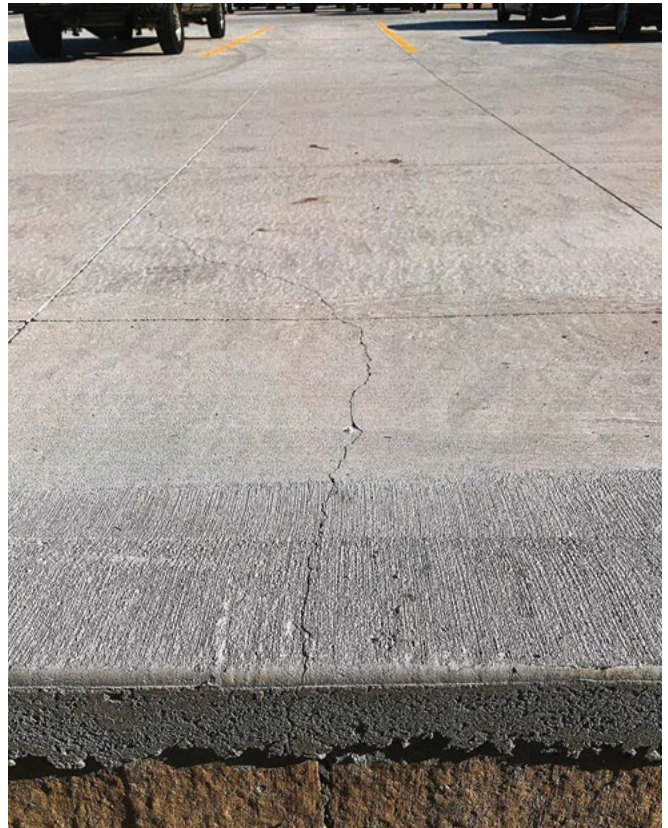

Jon Hansen, NRMCA, used with permission

Figure 20. Mid-panel cracking above an existing joint in a concrete curb and gutter unit

Details for Concrete Overlays of Asphalt Parking Lots

Figures 21 through 28 present sample construction details for concrete overlays of asphalt parking lots.

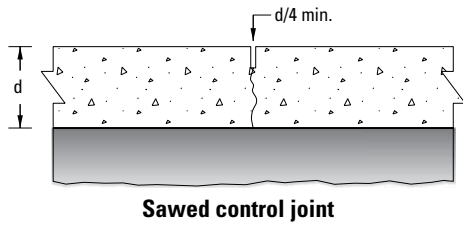

Recreated from Snyder & Associates, Inc., used with permission

Figure 21. Control joints for parking lots serving light vehicles

Key Points Related to Materials and Construction

Key topics related to materials and mixtures, pre-overlay repairs, and construction are summarized in Appendix C.

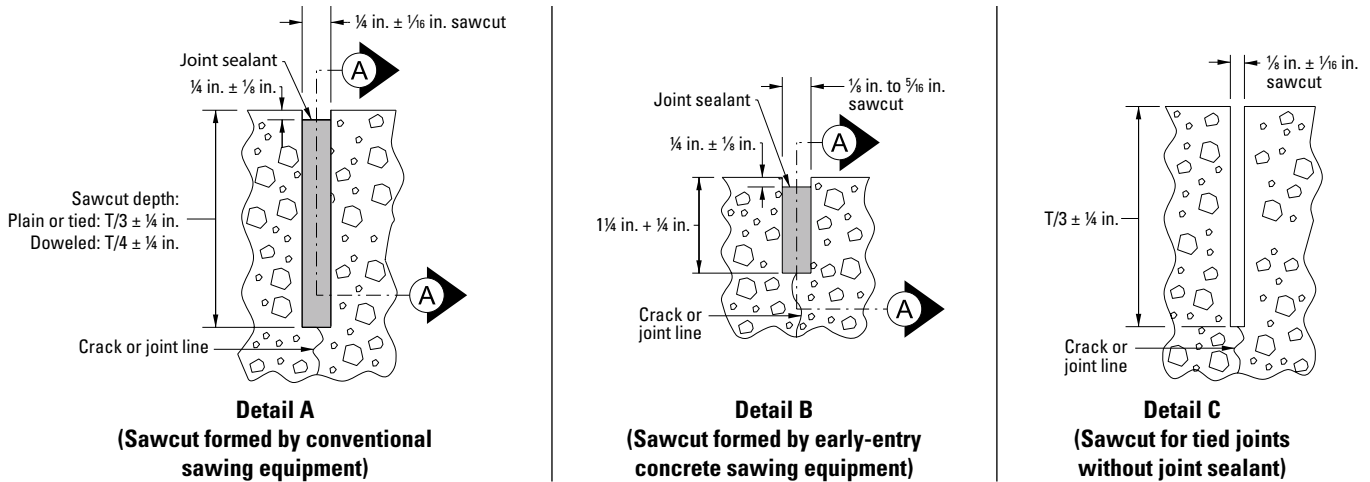

Recreated from Snyder & Associates, Inc., used with permission

Figure 22. Sawcut options

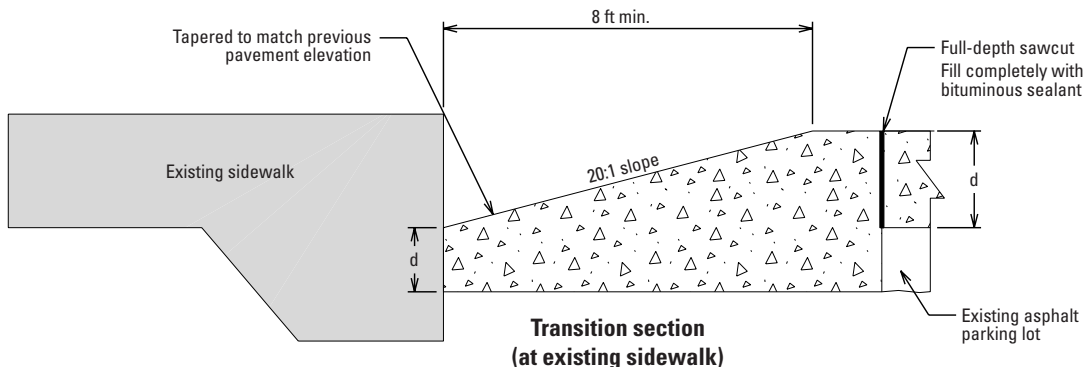
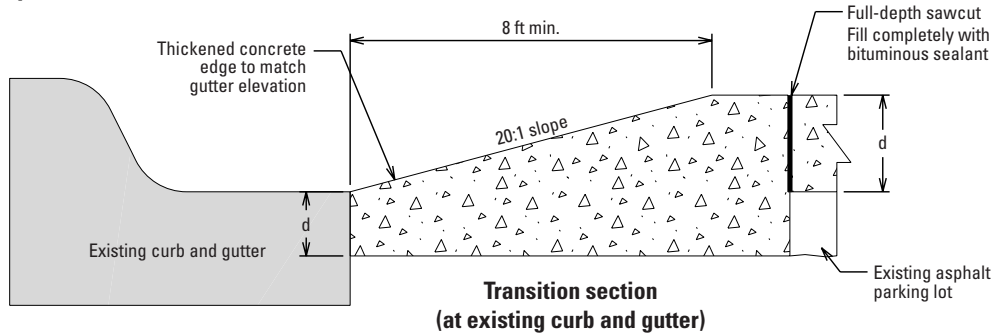

Recreated from Snyder & Associates, Inc., used with permission

Figure 23. Overlay transition into existing curbs

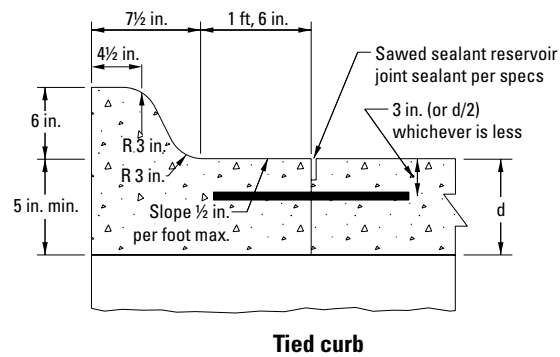
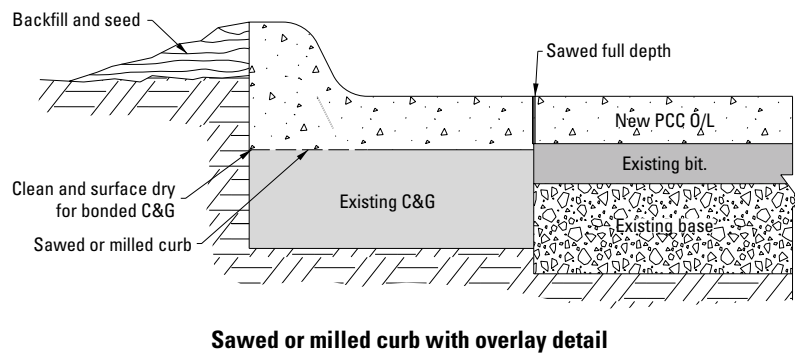
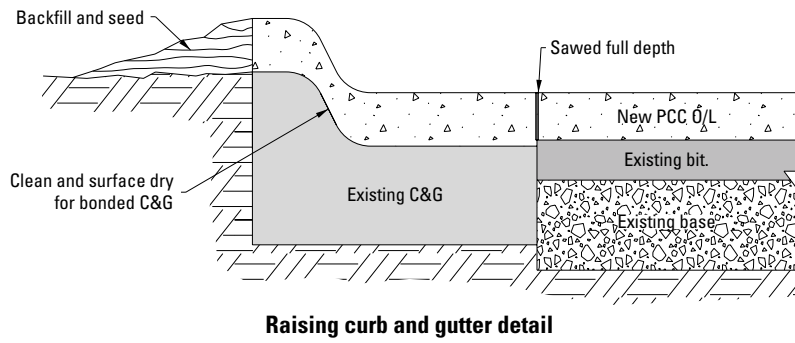
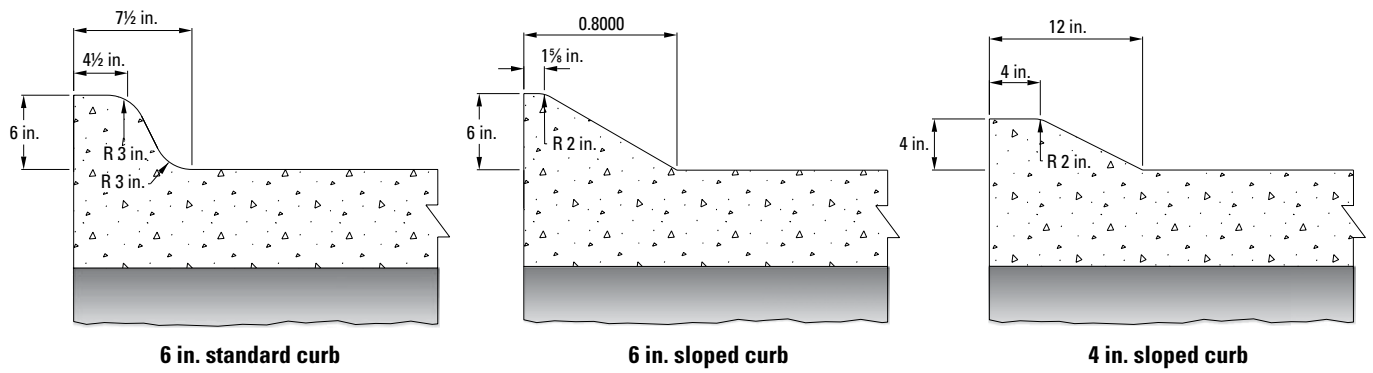

Recreated from Snyder & Associates, Inc., used with permission

Figure 24. Optional curb details

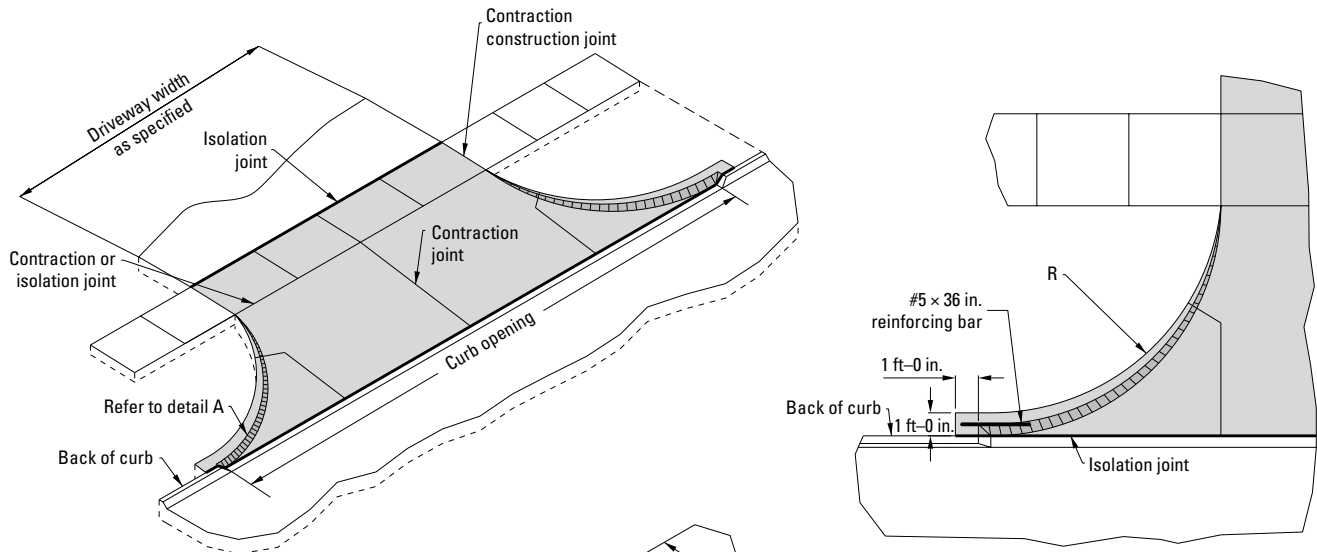

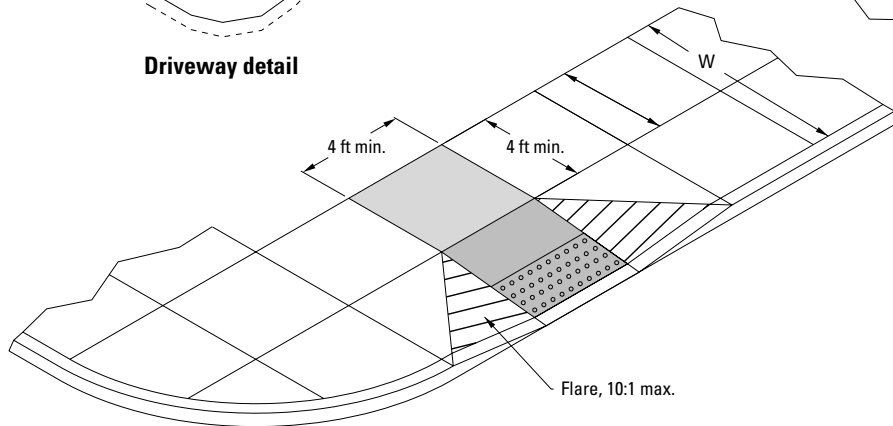

Driveway detail

Detail A



Perpendicular curb ramp

Key: Sidewalks and ramps

-  Curb ramp (8.3% max. running slope)
-  Turning space (2% max. cross slope)
-  Detectable warning

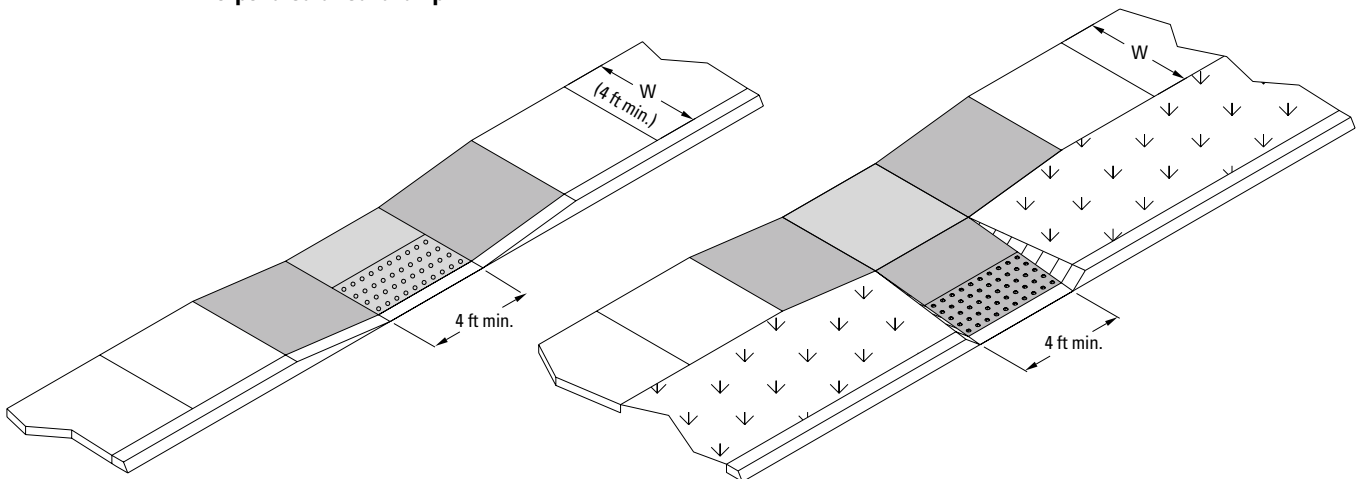

Parallel curb ramp

Perpendicular and parallel curb ramp

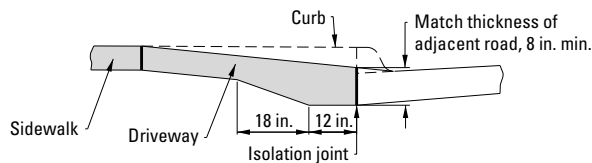

Typical driveway section

Recreated from Snyder & Associates, Inc., used with permission

Figure 25. Sidewalk ramps and driveways

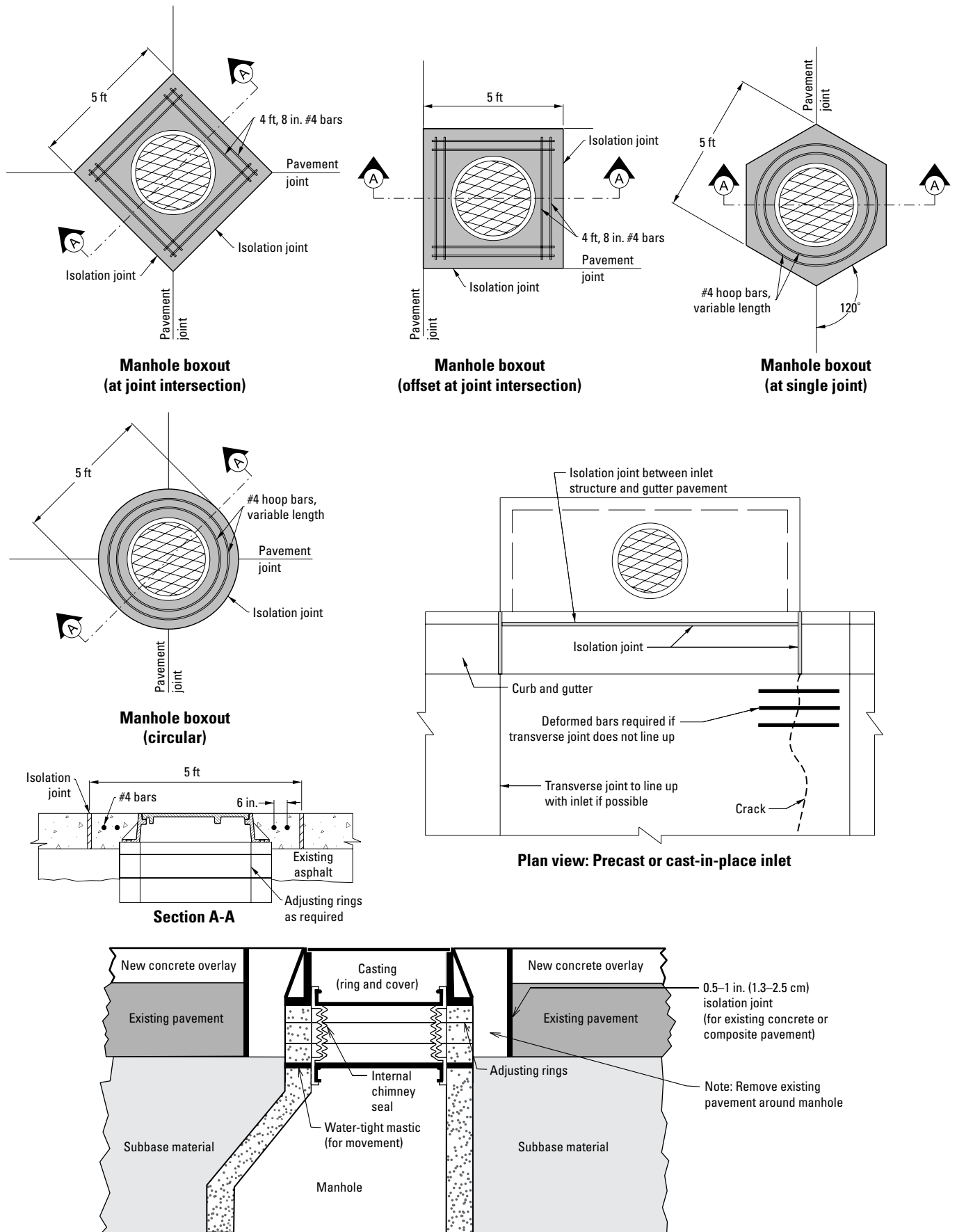

Recreated from Snyder & Associates, Inc., used with permission

Figure 26. Joints at manholes/intakes

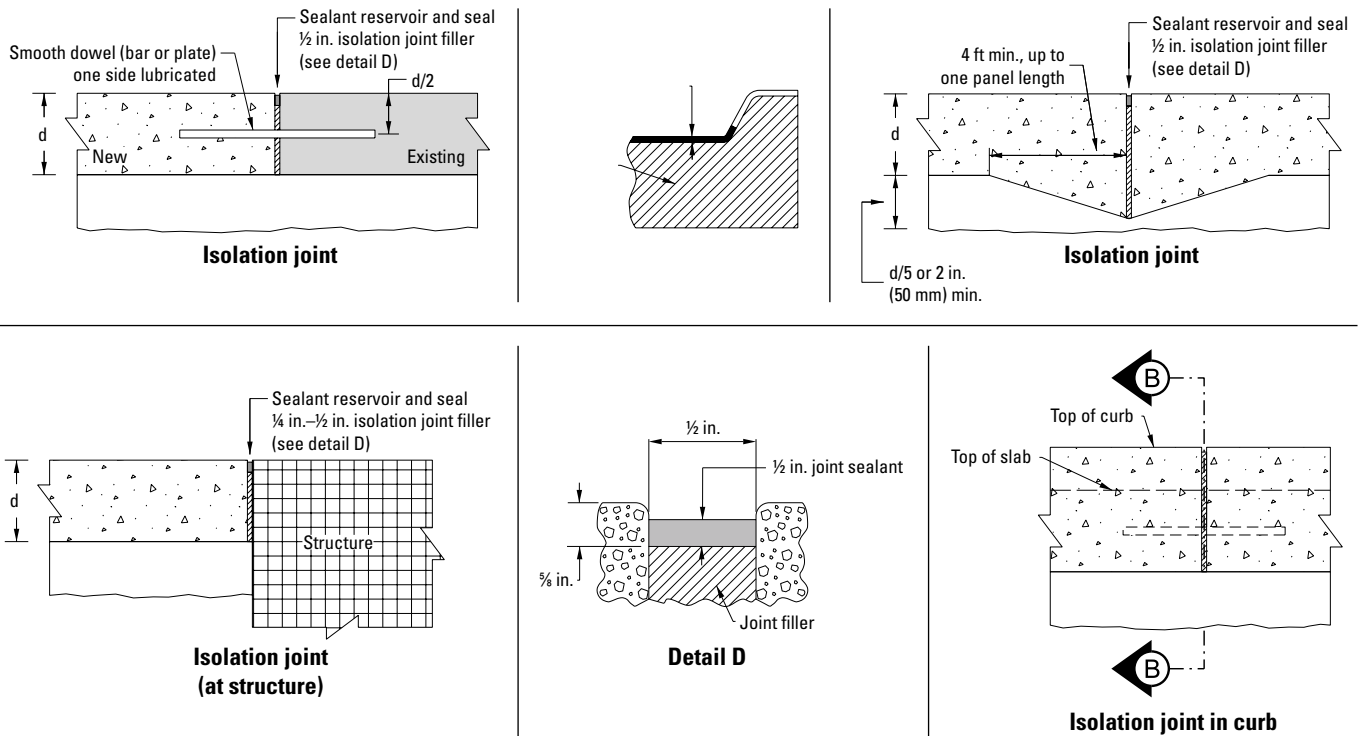

Recreated from Snyder & Associates, Inc., used with permission

Figure 27. Isolation joint details

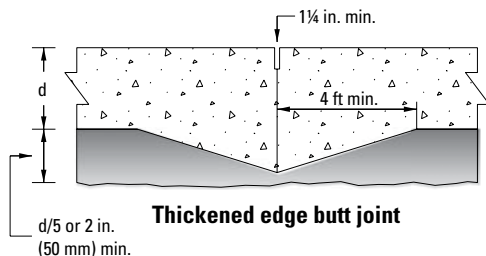
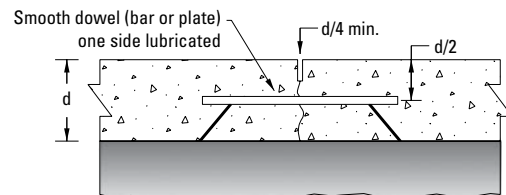
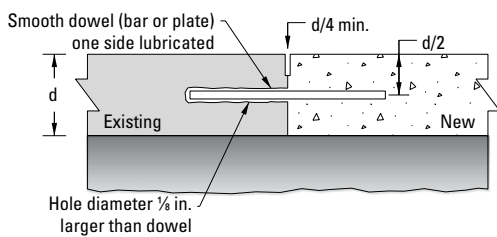
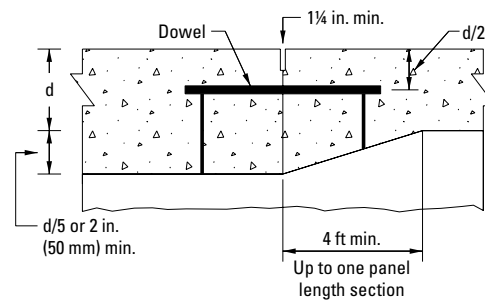
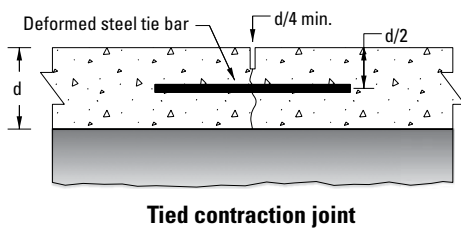

Recreated from Snyder & Associates, Inc., used with permission

Figure 28. Dowel or thickened edge joints

Surface Preparation for Existing Asphalt Pavements

Before the concrete overlay is placed, the surface of the existing asphalt pavement should be properly cleaned and prepared. This will allow the existing pavement to provide uniform support for the new concrete and will

improve the bond condition between the concrete and asphalt layers. If water is used to clean and prepare the existing asphalt surface, the surface should be dry prior to overlay placement.

Placement of Concrete Parking Lot Overlays

During the last few years, the use of mechanical screeds for the placement and consolidation of concrete overlays on asphalt parking lots has increased. Construction practices for thin concrete overlays frequently favor the use of mechanical screeds, such as laser-guided screeds, because the concrete area to be paved is much wider in parking lot paving than in street or highway paving. However, slipform pavers are still used for high-production paving in parking areas. Two types of placement are recommended depending on project conditions: block placement and strip placement.

Block Placement

When conditions allow, large block placements, as illustrated in Figure 29, provide the most efficient method of construction for large areas of paving. The reduced forming combined with the efficiencies of scale make this the most common placement technique for parking lots.

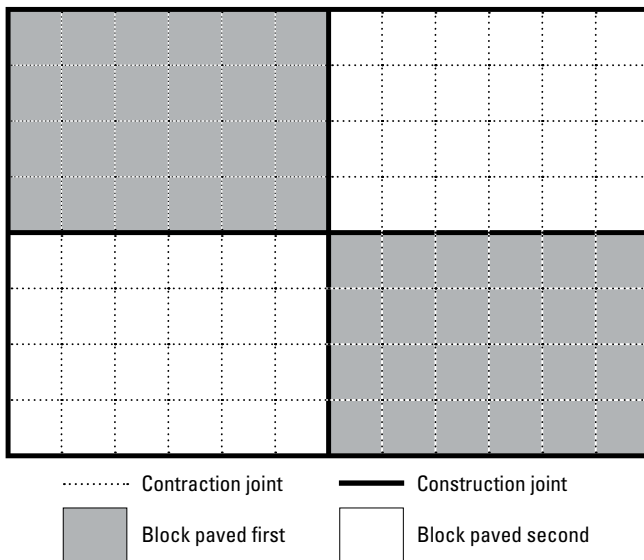

CP Tech Center

Figure 29. Block placement

Strip Placement

In some cases, the rate of concrete supply, weather conditions, texture required, or equipment availability makes the placement of long alternating strips the most efficient construction method. Strip placement, as shown in Figure 30, improves access on both sides of the paving operation to complete finishing, texturing, and curing operations. Construction joints can be slipformed or formed with bulkheads. The width of placement is usually dictated by the equipment, but widths should be multiples of the specified joint spacing. Wider strip placements often require the introduction of intermediate contraction joints. Intermediate longitudinal and transverse contraction joints can be installed at the specified joint spacing intervals.

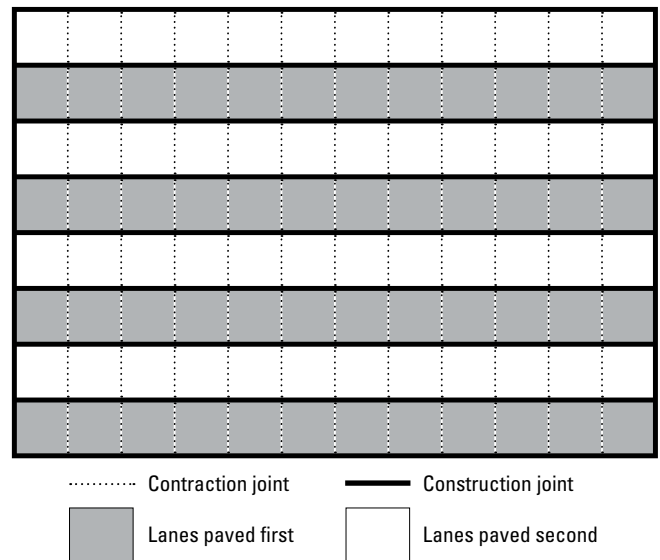

CP Tech Center

Figure 30. Strip placement

Equipment for Parking Lot Overlay Placement

The majority of the equipment used to place concrete overlays on parking lots is involved in the consolidation and screeding of the concrete into its final form. Most screeds used today (mechanical, roller, laser-guided, and truss screeds) are equipped with vibrators that consolidate the concrete as the screed strikes off the concrete to the desired grade and shape.

The discussion in this chapter mainly concentrates on the many types of screeds that can be used for projects of different sizes. The information contained herein is adapted from ACI 330.2R-17, *Guide for Design and Construction of Concrete Paving for Heavy Industrial and Trucking Facilities* (ACI Committee 330 2017).

Equipment for Hand/Wet Screeding

Although screeding of parking lot pavements is generally accomplished with a mechanical piece of equipment such as a laser-guided screed, slipform paving machine, or vibratory screed machine supported by edge forms, some smaller areas of a parking lot are best suited to hand screeding. Where surface tolerances are not critical, hand strike-off tools can be used with properly set grade stakes and wet screeds. Hollow magnesium or solid wood straightedges are commonly used for hand screeding concrete (Figure 31). The lengths of these straightedges vary up to 20 ft, and the cross-sectional dimensions are generally 1 to 2 in. wide by 4 to 6 in. deep.

When nonvibrating screeding devices are used, handheld gasoline- or electric-powered vibrators are used before screeding to ensure proper consolidation (Figure 32). On thin pavements, typical of most concrete overlays on parking lots, the use of short (5 in.) vibrators permits vertical insertion. If the slab is too thin to permit vertical insertion, the vibrator should be withdrawn slowly to prevent the introduction of voids below the pavement surface. Leaving the vibrator in the plastic concrete excessively can result in overvibration, which can lead to segregation and the loss of entrained air (ACI Committee 330 2021).

Handheld Vibratory Screeds

Handheld vibratory screeds have been developed to ease the process of hand screeding. They are comprised of a straightedge with a generally wider contact area than a nonvibrating hand screed, handles to allow the operator to stand in an upright position, and a vibratory attachment to induce surface vibration to aid in the screeding and leveling process (Figure 33).



Snyder & Associates, Inc., used with permission

Figure 31. Striking off with hand/wet screed



Hard Rock Construction, LLC, used with permission

Figure 32. Concrete vibrator



Will Gambill, Allen Engineering, used with permission

Figure 33. Handheld vibrating screed

Tools made specifically for screeding, such as handheld vibratory screeds or hollow magnesium straightedges, are preferred over randomly selected lumber, which can warp and twist during construction. Selection of the length and type of screed device to be used is somewhat dependent on the placement configuration. The maximum practical width of screed strips for hand screeding is approximately 16 ft. Therefore, the length of the hand screeding device should not be longer than 18 ft and should overlap previously placed strips of wet concrete by a minimum of 2 ft. Where strict elevation tolerances apply, it is wise to limit the width of screed strips and to overlap further. This method is generally used in irregular areas and on slabs less than 10,000 ft².

Roller Screeds

Roller screeds knock down, strike off, and can provide mild vibration or no vibration. The rollers can rotate at varying rates up to several hundred revolutions per minute, as required by the consistency of the concrete mixture. The rollers' direction of rotation is opposite to the screed's direction of movement. These screeds are most suitable for concrete mixtures with higher slump. Because these screeds provide mild or no vibration, thicker pavements may require additional vibration through the use of handheld vibrators. Figure 34 shows a nonvibrating roller screed powered by a gasoline engine or hydraulic power. This type of screed is generally used on straight and narrow placements of 10 to 20 ft wide.

Vibratory Truss Screeds

Vibratory truss screeds (Figure 35) are usually used to span between rigid forms and can be adjusted to compensate for any sag between the forms. They are commonly used on flat, crowned, or inverted concrete pavements up to 60 ft wide and are best suited for horizontal or nearly horizontal surfaces.



Cherne Contracting Corporation, used with permission

Figure 34. Nonvibrating roller screed

These screeds should vibrate at a low frequency—3,000 to 6,000 vibrations per minute (50 to 100 Hz)—and high amplitude to minimize wear on the machine and provide adequate depth of consolidation without creating an objectionable layer of fines at the surface. The specific frequency and amplitude should be coordinated with the behavior of the concrete mixture being used. However, note that excessive vibration can embed the coarse aggregate too deep and create a layer of mortar at the surface that may reduce the expected abrasion resistance properties of the hardened pavement surface.

To perform significant consolidation with a vibratory truss screed, the leading edge of the blade should be at an angle to the surface, and the proper surcharge (i.e., the height of unconsolidated concrete required to produce a finished surface at the proper elevation) should be carried in front of the leading edge. Depending on the concrete properties and the frequency and amplitude of the vibrator, a lightweight vibrating truss screed may not provide full-depth consolidation of pavement concrete, and additional vibration through the use of handheld vibrators may be needed.

Laser-Guided Screeds

Laser-guided screeds can be used to consolidate and strike off concrete to the proper grade and slope with great speed and efficiency. Concrete can be spread in front of the laser-guided screed using pumps or conveyors or by tailgating directly from concrete trucks. Tailgating is the most efficient method, but additional labor may be required during placement operations to repair any rutting caused by the concrete trucks and screed machines in thin or fatigued areas of the existing asphalt pavement.



Cherne Contracting Corporation, used with permission

Figure 35. Vibratory truss screed

Laser-guided screeds are useful in large block placements of 20,000 ft² or more. If the concrete overlay is 5 in. thick or more, special attention must be paid to the arrangement of the tie steel and dowel bars as necessary to allow the laser-guided screed to navigate through the pavement area. The intended construction method and steel layout should be discussed and agreed upon before construction begins. For placements involving steel, consideration should be given to the use of a pump or belt conveyor to place the concrete properly and with the greatest efficiency. Figure 36 shows a ride-on boom-style laser-guided screed, and Figure 37 shows a smaller walk-behind laser-guided screed.



Snyder & Associates, Inc., used with permission

Figure 36. Ride-on boom-style laser-guided screed



Myron Hilock, Somero Enterprises Inc., used with permission

Figure 37. Walk-behind laser-guided screed

Advantages of Using Laser-Guided Screeds

- Ensures accurate and efficient placement with three-dimensional model
- Allows for the use of mobile texturing and curing equipment

A typical placement using laser-guided screed equipment (Figure 38) is supplemented by a computer-generated three-dimensional (3D) model of the pavement surface provided by the designer. Once control points are set at the parking lot site, a computer on the screed equipment uses the model to check surface elevations and place the concrete to the proper elevations. The integrity and accuracy of current 3D profile software and the ability to integrate 3D profiles with laser-guided equipment offer a significant advantage for constructing concrete pavements to design elevations, help control the amounts of labor and concrete materials required for a project, and help establish positive drainage.

For large-scale parking lots where wide placements can be utilized, i.e., pour areas that have a width of over 100 ft, advancements in technology have resulted in equipment that can texture and cure the concrete surface (Figure 39). Texturing and curing the new pavement immediately after placement (Figure 40) minimizes the potential evaporation of mix water and reduces the risk of early-age cracking. Timely curing is especially critical on thinner pavements.



Michael Hoeft, K & M Concrete Construction, Inc., used with permission

Figure 38. Laser-guided screed



Michael Hoeft, K & M Concrete Construction, Inc., used with permission

Figure 39. Texturing and curing equipment applying curing material



Michael Hoeft, K & M Concrete Construction, Inc., used with permission

Figure 40. Placement using a laser-guided screed, with the screed on the left and the texturing and curing equipment on the right

Equipment for Slipform Paving

Mechanical paving equipment (Figure 41) can be used to slipform low-slump concrete to eliminate the need for fixed forms. Slipform paving is well suited to long access roads or roadway-type paving between different facilities or areas of paving within a facility where the strip placement method is used (see Figure 30). The slipform paver is used for high-production paving (typically over 50,000 ft²) with or without stringlines for grade control.

Slipform paving equipment is designed to spread, consolidate, and strike off the concrete in a single pass. This type of equipment performs best when operated in a continuous and steady forward movement. All delivery and spreading of concrete should be coordinated so as to provide uniform progress without frequent stopping and starting of the machine. Coordination with the concrete supplier is especially important for the timely delivery of adequate quantities of concrete with a uniformly low slump. Imperfections in the surface tolerances should be rectified using highway straightedges behind the placing and slipforming operation.

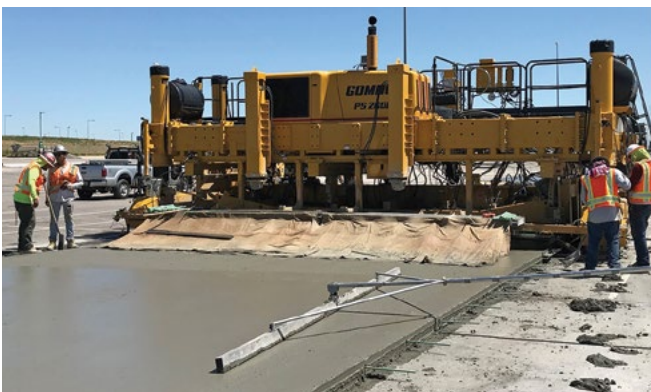

Angela James Folkestad, ACPA, CO/WY Chapter, used with permission

Figure 41. Slipform paver

If slipform paving equipment is used on a project, it is important that the concrete be of a suitable consistency to prevent excessive edge slump after the paving equipment has passed. When the slipform paver is to ride on the edge of a new concrete pavement, the concrete compressive strength should be greater than 2,000 psi; the time required to develop adequate strength can impact some schedules. Stringlines or other means for setting the grade should be checked frequently during the slipforming process.

Equipment for Sawing

For concrete overlays, the majority of sawing is performed to establish contraction joints. Sawcutting creates weakened planes in the pavement at preselected locations to establish the location and appearance of shrinkage cracks. The timing of sawing operations varies with the type of sawing equipment used and the concrete's rate of hydration. Since concrete overlays over asphalt can be as thin as 3 in., the surface-to-volume ratio is high, and the concrete can set rather quickly compared to full-depth concrete. Therefore, it is very important to have an adequate number of saws on site to keep up with the placement and curing operations.

Sawed joints should be cut as early as possible to prevent random cracking in the slab or cracking in front of the saw. However, sawing too early can cause edge spalling along the sawcut. Sawing should never be delayed until the next day after placement unless there is an extreme delay in the set time of the concrete mixture. Conventional sawcuts should be T/4 to T/3 deep, and if the joints are not to be sealed, a 1/8 in. wide sawcut is preferred. If the joints are to be sealed, they should be 1/4 in. wide.

The following three types of tools can be used for sawing joints:

- Conventional wet-cut (water-injection) saws
- Conventional dry-cut saws
- Early-entry dry-cut saws

Early-Entry Saws

Early-entry saws (Figure 42) are lighter than conventional saws and are normally used when earlier sawing is desired. These lighter saws require less concrete strength to support their weight, which allows them on the pavement sooner. As a result, joints can be cut before drying shrinkage stresses, which initiate cracking, develop in the concrete. The original early-entry saws could cut to a depth of only 1 to 2 in., but saws that can cut up to 3 in. are now commonly available. On some projects, early-entry sawcuts may need to be resawed to a specified depth and width to allow for the use of specified joint sealants. However, for most applications where hot-pour bituminous joint material is used to fill the sawcut reservoir, only one sawcut is needed.

Sawing should begin as soon as the concrete has hardened sufficiently to support the weight of the saw and to avoid raveling of the coarse aggregate. This timing typically

varies from one hour after finishing in hot weather to four hours after finishing in cold weather. Some night sawing may be required, depending on the contractor's schedule.

Early-entry dry-cut saws use diamond-impregnated blades and a skid plate that helps prevent spalling. Periodic checks should be completed to ensure that the skid plate is secure and tight to the pavement. Additionally, the skid plate should be changed when necessary to effectively control spalling. It is best to change the skid plate in accordance with the manufacturer's recommendations. Edge spalling along early-entry joints can also be minimized by using the correct early-entry blade for the type of aggregate(s) in the concrete.

Conventional Saws

Conventional saws (Figure 43) do not have skid plates, are heavier than early-entry saws, and require that the concrete gain more strength before sawing, causing sawing operations to be delayed. Joints produced using conventional saws are commonly made within three to four hours after finishing in hot weather, and later in cold weather. Conventional wet-cut saws are gasoline powered and, with the proper blades, are capable of cutting to depths of up to 12 in. or more.



Snyder & Associates, Inc., used with permission

Figure 42. Early-entry saws



Snyder & Associates, Inc., used with permission

Figure 43. Conventional joint saw

Texturing of Overlay Concrete

Weather-exposed concrete pavement requires a textured finish. Texturing provides better traction for tires, but, perhaps more importantly for parking lot applications, it also provides a slip-resistant walking surface when concrete is wet from rain, snow, or ice.

Though many different methods for texturing concrete are available, this chapter presents the methods that are most commonly used for concrete overlays and new parking lot construction. With any texturing method, the plasticity of the concrete, weather conditions, and timing all factor into the final texture.

Burlap Drag Texture

Dragging wet burlap over the pavement behind the final placement operation provides a uniformly light texture to concrete, as shown in Figure 44. This operation works best when the strip placement method is used and the placement width is narrow, generally not exceeding 28 ft. Burlap drag texturing follows all screeding and floating of the slab and precedes the application of curing compound. The burlap should be clean and free of dried concrete prior to application. To achieve the desired texture, water should be added to the burlap; however, it is important that excessive water is not applied. If the burlap drag produces a slurry film during application, the burlap has too much moisture.

Artificial Grass (AstroTurf) Drag Texture

Like burlap drag texturing, AstroTurf drag texturing follows all screeding and floating of the slab and precedes curing compound application. Also like burlap drag texturing, AstroTurf drag texturing is best suited for narrow strip paving. However, an AstroTurf drag leaves a slightly coarser texture on the concrete than a burlap drag, as shown in Figure 45. Like the burlap drag, the AstroTurf drag should be relatively clean and free of dried concrete prior to application to achieve the desired texture. Both the burlap and AstroTurf drag methods are normally applied longitudinally in the direction of concrete placement.

Broom Texture

Broom texture is applied with either a pole-mounted broom operated by one person (the pole broom method), a pull rope-mounted broom operated by two people on either side of the placement operation (the pull broom method), or a broom mounted to the extension boom



FHWA, used with permission

Figure 44. Burlap drag texturing and the resulting texture

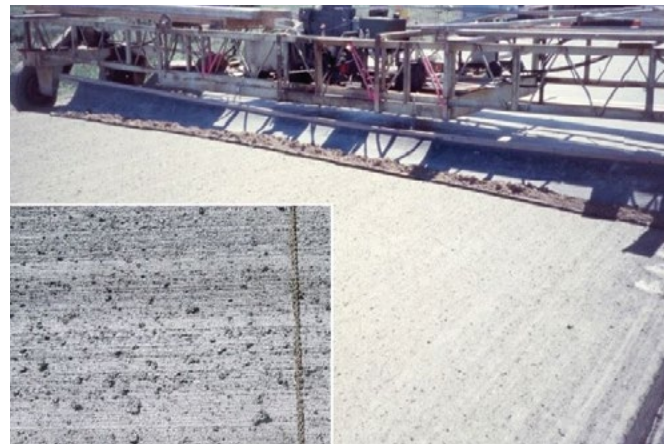

Minnesota Department of Transportation, used with permission

Figure 45. Artificial grass (AstroTurf) drag texturing and the resulting texture



Jon Hansen, NRMCA, used with permission

Figure 46. Broom texture

of a placement machine (the boom broom method). All three methods result in similar finished textures. Broom texturing follows screeding and floating operations and precedes curing compound application and sawcutting. Figure 46 shows a finished broom texture.

Pole Broom Method

This method of texturing is typically accomplished by one person using a broom attached to a handle or extension pole, as shown in Figure 47, though sometimes another person on the opposite side of the pavement assists in the operation. The operator brooms across the slab transversely at a 90-degree angle to the direction of concrete placement. This method is normally used on slabs 20 ft wide or less.

Pull Broom Method

This texturing method is accomplished using a broom pulled on a rope by two workers, one on each side of the placement operation (Figure 48). The broom, normally 4 to 6 ft wide, is wider than that used for the pole broom method. As the broom is pulled across the slab by one worker, the broom is pulled back by the other worker, with a small overlap of the broom's path allowed on each pass. This method has been successfully used in slabs up to 60 ft wide. Figure 49 shows the texture resulting from the pull broom method.

Boom Broom Method

The newest method for broom texturing is the use of a broom mounted to the extension boom of a placement machine (Figure 50). Unlike the pole broom or pull broom methods, the boom broom method applies texture longitudinally in the direction of concrete placement. The texturing broom is typically of equal width to the boom on which it is mounted, and the boom extends an equal distance across the width of the newly screeded concrete as the concrete placement machine it follows. Therefore, boom broom texturing is not limited in width like other broom texturing methods. Additionally, a boom broom can apply curing compound directly behind the brooming operation. Boom broom texturing and curing follows all screeding and floating and precedes final sawcutting. Figure 51 shows the texture resulting from the boom broom method.



GBR Paving (<https://www.youtube.com/watch?v=Nr24a2wgdBY>)

Figure 47. Pole broom method



Dale Mescher, BARD Materials, used with permission

Figure 48. Pull broom method



Dale Mescher, BARD Materials, used with permission

Figure 49. Finished texture resulting from the pull broom method



Michael Hoeft, K & M Concrete Construction, Inc., used with permission

Figure 50. Boom broom method



Michael Hoeft, K & M Concrete Construction, Inc., used with permission

Figure 51. Finished texture resulting from the boom broom method

Project Profiles of Concrete Overlays of Asphalt Parking Lots

Thorncreek Golf Course Thornton, Colorado

Project Information

Key project information is summarized in Table 7.

Table 7. Project information for the Thorncreek Golf Course parking lot overlay

Year of overlay	2018
Location	13555 Washington St. Thornton, Colorado
Project type	Golf course parking lot
Project size	92,000 ft ²
Concrete overlay thickness	3 to 4 in.
Mix design	4,000 psi compressive strength with macrofibers (4 lb/yd ³)
Existing asphalt thickness	3 to 5 in.
Joint spacing	5 ft
Contractor	SLV Quality Concrete, LLC Monte Vista, Colorado
Placement type	Laser-guided screed, roller screed
Special accomplishments	Existing curb, gutter, and sidewalk overlaid with new concrete pavement

Overview

After investing over \$7 million in a major facelift for its Thorncreek Golf Course, the city of Thornton, Colorado, was left with an existing 92,000 ft² asphalt parking lot that had been neglected for years (Figure 52). The budget and timeframe for construction were both tight, presenting a significant challenge to city engineers.

Working with National Ready Mixed Concrete Association (NRMCA) Vice President, Local Paving, Don Clem, PE, and utilizing NRMCA’s Design Assistance Program, NRMCA member Dave Gray of GCC of America developed a concrete overlay pavement design and life-cycle cost analysis for the Thorncreek Golf Course parking lot. The design and analysis demonstrated that a concrete overlay of the existing asphalt lot would cost slightly less than removing and replacing the asphalt while providing significant savings to the city over a 30-year service life. In addition, the main drive, curb, gutter,

and sidewalk would also be overlaid, creating a beautiful approach to the clubhouse with no increase in cost.

“The city specified a concrete pavement overlay of the asphalt lot due to speed of construction, which was a critical element to this project,” says Richard Nickson, in-house engineer for the City of Thornton. “The city also expects to save more than \$110,000 over the next 30 years due to reduced maintenance costs. And the bright concrete pavement announced to the community that the two-year renovation project was now complete, and the golf course was once again open for business.” Figure 53 shows the completed concrete overlay on the Thorncreek Golf Course parking lot.



City of Thornton, Colorado, used with permission

Figure 52. Existing asphalt parking lot of the Thorncreek Golf Course before concrete overlay construction

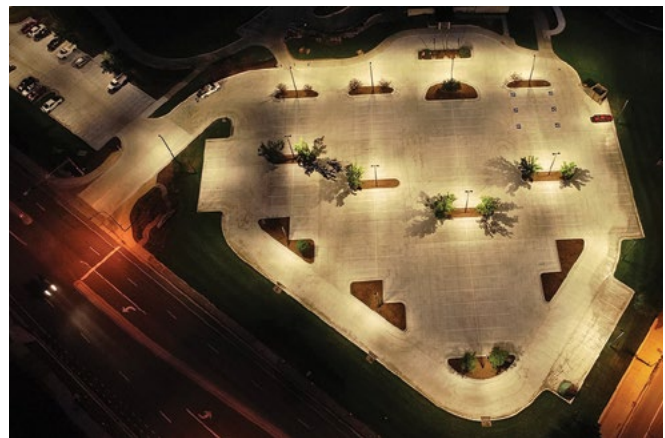

City of Thornton, Colorado, used with permission

Figure 53. Completed concrete overlay on the Thorncreek Golf Course parking lot, which provides greater durability and increased reflectivity for better overall performance

Denver International Airport Denver, Colorado

Project Information

Key project information is summarized in Table 8.

Table 8. Project information for the Denver International Airport parking lot overlay

Year of overlay	2019–2020
Location	24300 East 75th Ave. Denver, Colorado
Project type	Airport shuttle parking lot
Project size	34.5 acres
Concrete overlay thickness	4.5 in.
Mix design	4,500 psi compressive strength
Existing asphalt thickness	5 to 7 in.
Joint spacing	6 ft
Contractor	Concrete Works of Colorado Lafayette, Colorado
Placement type	Slipform concrete paver
Special accomplishments	Existing curb overlaid with new curb; bus lanes placed as 10 in. full-depth concrete on 8 in. aggregate base course

Overview

After 20 years of continuous service, the Pikes Peak Shuttle Lot operated by Denver International Airport (DEN) had reached the end of its service life and needed to be replaced. DEN Landside Engineering considered either the removal and replacement of the existing 5 to 7 in. asphalt pavement, which was supported by a 12 in. lime-treated base, or the construction of a 5 in. unreinforced concrete overlay placed directly over the existing asphalt. The initial cost of the concrete overlay option was about 30 percent lower than that of the remove-and-replace option.

DEN Landside Engineering prepared a life-cycle cost analysis comparing the two options, which indicated that the concrete overlay option would provide substantial savings over its 40-year life. Based on this analysis and the fact that the concrete overlay option was less expensive initially, DEN opted to undertake the largest concrete

overlay parking lot project in the US in a bid to renew the service life of the existing pavement at a fraction of the cost of full-depth reconstruction. Figure 54 shows the construction of the concrete overlay on the existing asphalt pavement, and Figure 55 shows the parking lot after construction was completed.

Construction began in 2019, but only about 55 percent of the project was built initially before the COVID-19 pandemic disrupted the construction schedule. Following an evaluation of the initial test strips, the nominal thickness was reduced to 4.5 in. and tie bars at the construction joints were eliminated. The only tie bars ultimately used were in the lanes along the perimeter of the lot, providing a ring of concrete to hold the lot together. Despite the setbacks, work was completed in time for the 2020 holiday season.



Don Clem, National Ready Mixed Concrete Association, used with permission

Figure 54. Concrete overlay placement on the Pikes Peak Shuttle Lot at the Denver International Airport, with the existing asphalt pavement used as the base

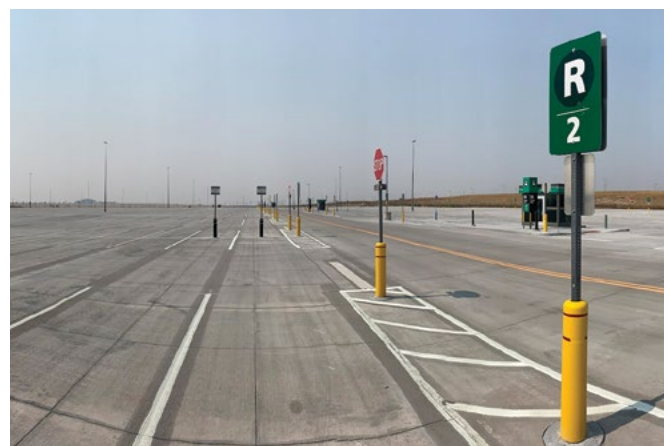

Don Clem, National Ready Mixed Concrete Association, used with permission

Figure 55. Completed concrete overlay on the Pikes Peak Shuttle Lot at the Denver International Airport

Super Ron's Food Center Pulaski, Wisconsin

Project Information

Key project information is summarized in Table 9.

Table 9. Project information for the Super Ron's Food Center parking lot overlay

Year of overlay	2021
Location	960 County Truck Hwy B Pulaski, Wisconsin
Project type	Retail food
Project size	80,000 ft ²
Concrete overlay thickness	4 to 5 in.
Mix design	Contractor mix design: 4,000 psi compressive strength with entrained air
Existing asphalt thickness	3 in.
Joint spacing	5 ft nominal
Contractor	Milis Flatwork Kaukauna, Wisconsin
Placement type	Laser-guided screed
Special accomplishments	Concrete overlay included delivery truck lanes and car parking area

Overview

Super Ron's Food Center is a family-run business with multiple locations that has specialized in scratch bakery items, fresh meats, and homemade deli items for over 50 years. In 2020, the original asphalt parking lot for the Pulaski, Wisconsin, location was approximately 15 years old and in need of replacement (Figure 56).

Milis Flatwork of Wisconsin was contracted to construct a concrete overlay for the parking lot. The company is both an American Society of Concrete Contractors (ASCC) member and a National Ready Mixed Concrete Association (NRMCA) Parking Lot Boot Camp contractor.

As an engineer, company owner Dylan Milis designs both concrete overlays and full-depth concrete paving applications. Milis Flatwork has completed numerous overlays for a wide range of applications, from private offices to industrial parking lots, and uses a proprietary "parking lot mix design" to maximize the pavement's potential. Figure 57 shows the completed concrete overlay on the parking lot of Super Ron's Food Center in Pulaski, Wisconsin.



© 2021 Google Earth

Figure 56. Asphalt parking lot of Super Ron's Food Center in Pulaski, Wisconsin, before concrete overlay construction (2020)



Milis Flatwork, used with permission

Figure 57. Completed concrete overlay on the parking lot of Super Ron's Food Center in Pulaski, Wisconsin (2021)

Parker-Hannifin Manitowoc, Wisconsin

Project Information

Key project information is summarized in Table 10.

Table 10. Project information for the Parker-Hannifin parking lot overlay

Year of overlay	2021
Location	1717 Dufek Dr. Manitowoc, Wisconsin
Project type	Industrial
Project size	93,000 ft ²
Concrete overlay thickness	4 to 5 in.
Mix design	Contractor mix design: 4,000 psi compressive strength with entrained air and fibers
Existing asphalt thickness	3.5 in.
Joint spacing	6 ft nominal
Contractor	Milis Flatwork Kaukauna, Wisconsin
Placement type	Laser-guided screed
Special accomplishments	Concrete overlay included both heavy-duty and light-duty areas

Overview

With operations in 50 countries, Parker-Hannifin is the world's leading diversified manufacturer of motion and control technologies and systems, providing precision-engineered solutions for a wide variety of mobile, industrial, and aerospace markets. The asphalt parking lot at the company's Manitowoc, Wisconsin, facility was in need of repair after several years in service (Figure 58).

Milis Flatwork of Wisconsin was contracted to construct a concrete overlay for the parking lot. The company is both an American Society of Concrete Contractors (ASCC) member and a National Ready Mixed Concrete Association (NRMCA) Parking Lot Boot Camp contractor.

As an engineer, company owner Dylan Milis designs both concrete overlays and full-depth concrete paving applications. Milis Flatwork has completed numerous overlays for a wide range of applications, from private offices to industrial parking lots, and uses a proprietary “parking lot mix design” to maximize the pavement's potential. Figure 59 shows the completed concrete overlay on the parking lot of the Parker-Hannifin facility in Manitowoc, Wisconsin.



© 2021 Google Earth

Figure 58. Asphalt parking lot of the Parker-Hannifin facility in Manitowoc, Wisconsin, before concrete overlay construction



Milis Flatwork, used with permission

Figure 59. Completed concrete overlay on the parking lot of the Parker-Hannifin facility in Manitowoc, Wisconsin (2021)

References

- AASHTO. 2021. AASHTOWare Pavement ME Design. American Association of State Highway and Transportation Officials, Washington, DC. <https://me-design.com/MEDesign/>.
- ACI Committee 121. 2008. *Guide for Concrete Construction Quality Systems in Conformance with ISO 9001*. ACI PRC-121-08. American Concrete Institute, Farmington Hills, MI.
- ACI Committee 211. 2009. *Standard Practice for Selecting Proportions for Normal, Heavyweight, and Mass Concrete (Reapproved 2009)*. ACI PRC-211.1-91. American Concrete Institute, Farmington Hills, MI.
- ACI Committee 221. 2001. *Guide for Use of Normal Weight and Heavyweight Aggregates in Concrete (Reapproved 2001)*. ACI PRC-221-96. American Concrete Institute, Farmington Hills, MI.
- ACI Committee 301. 2020. *Specifications for Concrete Construction*. ACI SPEC-301-20. American Concrete Institute, Farmington Hills, MI.
- ACI Committee 304. 2009. *Guide for Measuring, Mixing, Transporting, and Placing Concrete (Reapproved 2009)*. ACI PRC-304-00. American Concrete Institute, Farmington Hills, MI.
- ACI Committee 330. 2017. *Guide for Design and Construction of Concrete Paving for Heavy Industrial and Trucking Facilities*. ACI 330.2R-17. American Concrete Institute, Farmington Hills, MI.
- ACI Committee 330. 2021. *Commercial Concrete Parking Lots and Site Paving Design and Construction—Guide*. ACI PRC-330-21. American Concrete Institute, Farmington Hills, MI.
- ACPA. 2006. *Design of Concrete Pavement for City Streets*. Publication IS184.02P. American Concrete Pavement Association, Skokie, IL.
- Adrian, W., and R. Jabanputra. 2005. *Influence of Pavement Reflectance on Lighting for Parking Lots*. PCA R&D Serial No. 2458. Portland Cement Association, Skokie, IL.
- Asphalt Institute. n.d. Pavement Distress Summary. Asphalt Institute. <https://www.asphaltinstitute.org/engineering/maintenance-and-rehabilitation/pavement-distress-summary/>.
- Bordelon, A., and J. Roesler. 2019. *Residual Strength Estimator for Fiber-Reinforced Concrete Overlays*. National Concrete Pavement Technology Center, Ames, IA. https://intrans.iastate.edu/app/uploads/2019/03/Residual-Strength-Estimator-for-FRC-Overlays-April-19-2019_public.xlsx.
- Christopher, B. R. 2000. *NCHRP Synthesis of Highway Practice 285: Maintenance of Highway Edgedrains*. National Cooperative Highway Research Program, Washington, DC.
- Daleiden, J. F. 1998. *Video Inspection of Highway Edgedrain Systems*. FHWA-SA-98-044. Federal Highway Administration, Washington, DC.
- Feng, M., and J. M. Vandenbossche. 2012. Establishing Effective Linear Temperature Gradients for Bonded Concrete Overlays on Asphalt Pavements. *Transportation Research Record: Journal of the Transportation Research Board*, Vol. 2305, No. 1, pp. 24–31.
- Gajda, J., and M. VanGeem. 2001. *A Comparison of Six Environmental Impacts of Portland Cement Concrete and Asphalt Cement Concrete Pavements*. PCA R&D Serial No. 2068. Portland Cement Association, Skokie, IL.
- IDOT. 2022. *Qualified Product List: Synthetic Fibers*. Illinois Department of Transportation, Bureau of Materials, Springfield, IL. <https://idot.illinois.gov/Assets/uploads/files/Doing-Business/Specialty-Lists/Highways/Materials/Materials-&-Physical-Research/Concrete/syntheticfibers.pdf>.
- NRMCA. n.d. Concrete Pavement Analyst. National Ready Mixed Concrete Association.
- Packard, R. G. 1984. *Thickness Design for Concrete Highway and Street Pavements*. Portland Cement Association, Skokie, IL.

Popovics, S. 1986. Chemical Resistance of Portland Cement Mortar and Concrete. *Corrosion and Chemical Resistant Masonry Materials Handbook*. Noyes Publications, Park Ridge, NJ.

Roesler, J., A. Bordelon, A. Ioannides, M. Beyer, and D. Wang. 2008. *Design and Concrete Material Requirements for Ultra-Thin Whitetopping*. FHWA-ICT-08-016. UILU-ENG-2008-2003. University of Illinois at Urbana-Champaign, Urbana, IL. <http://hdl.handle.net/2142/9685>.

Miller, J. S., and W. Y. Bellinger. 2014. *Distress Identification Manual for the Long-Term Pavement Performance Project*. FHWA-HRT-13-092. Federal Highway Administration, McLean, VA. <https://www.fhwa.dot.gov/publications/research/infrastructure/pavements/ltp/13092/13092.pdf>.

Van Dam, T., and P. Taylor. 2009. *Building Sustainable Pavements with Concrete*. National Concrete Pavement Technology Center, Ames, IA. https://intrans.iastate.edu/app/uploads/2018/08/Sustainability_Briefing.pdf.

Wathne, L. 2010. Sustainability Opportunities with Pavements: Are We Focusing on the Right Stuff? *Proceedings: International Conference on Sustainable Concrete Pavements: Practices, Challenges, and Directions; Sacramento, California; September 15–17, 2010*. pp. 421–442.

Appendix A. Identifying Pavement Distresses and Levels of Severity

The discussion and distress descriptions presented in this appendix are intended to help stakeholders conduct visual inspections and core analyses of existing asphalt parking lot pavements. Other resources for evaluating asphalt pavement distresses include the following:

- *Distress Identification Manual for the Long-Term Pavement Performance Project* (Miller and Bellinger 2014)
- Pavement Distress Summary (Asphalt Institute n.d.)

Causes of Distress

Most asphalt distresses result from environmental factors, traffic loads, or a combination of these factors.

Environmental factors include hot and cold weather, the presence of water in the subgrade/subbase, and frost heave. High temperatures soften the asphalt binder, allowing heavy tire loads to deform the pavement into ruts. Paradoxically, high heat and strong sunlight also cause the asphalt to oxidize, making it stiffer, less resilient, and more susceptible to cracking. Cold temperatures can cause the asphalt to contract and, as a result, crack. Cold asphalt is also less resilient and more likely to crack.

Cracking can also result from the presence of water in the subbase/subgrade and the freezing of groundwater. Water trapped under the pavement softens the subgrade/subbase, making the asphalt more vulnerable to traffic loads and thus to cracking. In cold climates, the freezing of groundwater and the resulting frost heave can also crack asphalt pavement. Filling cracks with bitumen can be a temporary fix for water- and frost-related distresses, but only proper construction—i.e., ensuring that groundwater drains away from the road—can mitigate this problem.

In climates that experience freeze-thaw cycles, the thawing of frozen groundwater in the spring can also lead to distress. During the spring, frozen groundwater thaws from the top down, trapping water in a layer of saturated soil between the pavement and the still-frozen soil underneath. This layer of saturated soil provides little support for the road above, leading to the formation of potholes. This is more of a problem for silty or clay soils than sandy or gravelly soils.

In addition to environmental factors, traffic loads can lead to distresses in asphalt pavements. The loads from vehicle wheels cause asphalt pavements to flex slightly, potentially resulting in fatigue cracking, which can lead to alligator cracking. If the subgrade/subbase is stable, asphalt parking

lot pavements should not experience major damage from light vehicle loadings, such as those from cars and pickup trucks. However, unless designed and constructed for heavier loads, parking lot entrances, access ways, and truck lanes can experience damage from heavy loads, such as those from large trucks and waste disposal vehicles. The damage a vehicle causes is proportional to the axle load raised to the fourth power; thus, doubling the weight on an axle causes 16 times as much damage.

Vehicle speed also plays a role in the damage caused by traffic loads. Slow-moving heavy vehicles stress the pavement over a longer period of time, increasing rutting and cracking in the asphalt.

Severity of Distress

In this guide, asphalt distress severity is classified as either of the following:

- Low- to medium-severity (surface) distresses
- High-severity (subsurface or loading) distresses

Normally, pavements only exhibiting low- to medium-severity distresses do not require major repair or rehabilitation prior to the placement of an overlay because a stable, uniform base exists.

High-severity distresses, however, must be repaired or removed prior to the placement of an overlay. If high-severity distresses are so numerous that spot repairs would not be cost-effective, then construction of an unbonded concrete overlay may be justified. In such cases, the existing asphalt remains in place, though it may be milled as necessary to meet elevation restrictions. Care must be exercised to ensure that the distresses are not the result of a poor subgrade/subbase. The subgrade/subbase of the asphalt parking lot must be stable and uniform to support the new pavement.

Types of Distress

Asphalt distresses can include various types of cracking, raveling, rutting, shoving (slippage), potholes/popouts, and grade depressions.

Figure A-1 presents thumbnail images of low- to medium-severity and high-severity manifestations of eight common types of asphalt distress. Figures A-2 through A-17 and the accompanying discussions provide more detailed descriptions of these asphalt distresses, their causes, and their levels of severity.



Photos: Snyder & Associates, Inc., used with permission

Figure A-1. Thumbnails of asphalt pavement distresses

Alligator Cracking

Alligator cracking is a series of interconnected cracks caused by fatigue failure of the asphalt surface under repeated traffic loading. In thin pavements, cracking initiates at the bottom of the asphalt layer where the tensile stress is the highest, then propagates to the surface as one or more longitudinal cracks. However, top-down cracking can occur when high tensile stresses in the surface develop through asphalt binder aging. Fewer loading cycles are needed to cause failure for larger loads, thinner asphalts, and wetter subbases/subgrades.

Asphalt parking lot pavements that are weakened during the spring thaw are more susceptible to fatigue failure at that time than they are during the rest of the year.

Low- to medium-severity alligator cracking (Figure A-2) appears as an area of interconnected cracks forming a complete system. The cracks may be slightly spalled, but no pumping or loose pieces are evident.

High-severity alligator cracking (Figure A-3) appears as pockets of vertical surface depressions, along with small, severely spalled, interconnected cracks forming a complete pattern; pieces of pavement may move when subject to traffic. A parking lot profile that has dropped or is irregular may indicate pumping.

If severe alligator cracking is predominant throughout the project area, the parking lot is not a good candidate for a concrete overlay. Consideration should be given to constructing a new pavement, including repairs to the subbase/subgrade where necessary.



Snyder & Associates, Inc., used with permission

Figure A-2. Low- to medium-severity alligator cracking



Snyder & Associates, Inc., used with permission

Figure A-3. High-severity alligator cracking

Summary of Possible Causes

- Excessive loading
- Weak surface, base, or subgrade
- Thin surface or base
- Poor drainage
- Dried-out asphalt binder from oxidation (aging)
- Any combination of the above

Required Pre-overlay Repairs

No pre-overlay repairs are required for low- to medium-severity cracking.

For high-severity cracking, patching is required for spot locations. Use a pavement saw extending at least 1 ft outside the distressed area to outline the concrete patch. If the repair is isolated, completely remove the deteriorated asphalt to the full depth and repair the underlying support system if it is damaged. The area can be filled with concrete during overlay construction. Subbase/subgrade excavation may be necessary to reach firm support, or the installation of a drainage system may be required. An asphalt patch should not be used because the new asphalt will not bond with the concrete overlay.

Block Cracking

Block cracking is a series of interconnected cracks that divide the pavement into rectangular pieces. This type of cracking is typically caused by the inability of the asphalt binder to expand and contract with temperature cycles because the asphalt has hardened due to binder aging or a poor choice of binder in the mix design.

Localized areas of the pavement surface that exhibit vertical drops should not be confused with block cracking. Such areas are more likely to be alligator cracks caused by poor subgrade support and fatigue fracture.

For low- to medium-severity block cracking (Figure A-4), cracks are $\frac{3}{4}$ in. wide or less with raveled edges.

For high-severity block cracking (Figure A-5), cracks are wider than $\frac{3}{4}$ in. or are adjacent to areas of severe random cracking that may also exhibit vertical distortion.

If severe block cracking occurs throughout the parking lot, then the lot is not a good candidate for a concrete overlay.



Snyder & Associates, Inc., used with permission

Figure A-4. Low- to medium-severity block cracking

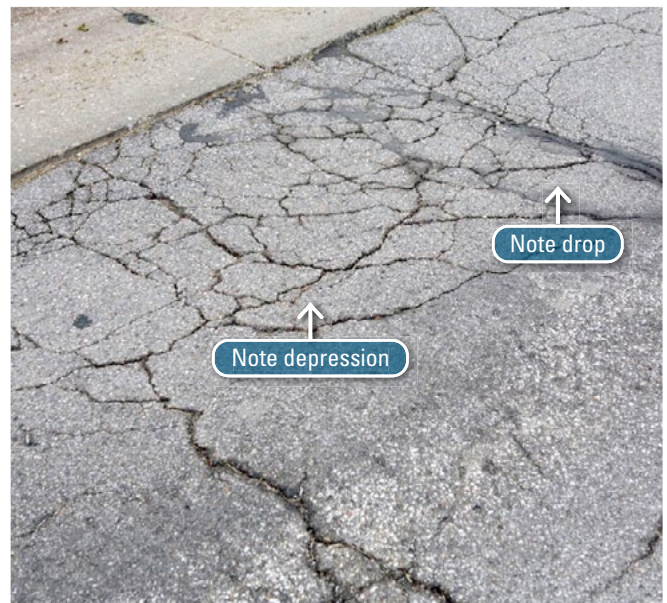

Photo: Snyder & Associates, Inc., used with permission

Figure A-5. High-severity block cracking

Summary of Possible Causes

- Asphalt binder aging (oxidation)
- Poor choice of asphalt binder in the mix design

Required Pre-overlay Repairs

No pre-overlay repairs are required for low- to medium-severity block cracking as long as no loose pieces of asphalt are present. Fill and seal cracks that are ½ in. to ¾ in. wide with hot-pour bituminous material.

If high-severity block cracking is not predominant in the parking lot but is located only in isolated areas, then remove or mill the full depth of the asphalt in those locations and replace with concrete during overlay construction. The locations of these full-depth repairs should be properly isolated from the rest of the concrete overlay by strategically locating contraction joints or construction joints at the perimeter of the repairs.

Potholes

Potholes are small, bowl-shaped depressions in the pavement surface that typically penetrate through the surface layer and sometimes all the way through the asphalt down to the subbase course. Generally, potholes are the end result of severe alligator cracking; they initiate when the interconnected cracks in an area of alligator cracking create small chunks of pavement that are dislodged as vehicles drive over them.

Low- to medium-severity potholes (Figure A-6) are less than 1 in. deep for asphalt greater than 4 in. thick and cover a small and isolated area.

High-severity potholes (Figure A-7) are more than 1 in. deep and/or cover a large area.

If significant potholes combined with alligator cracking occur throughout the asphalt pavement, the parking lot is not a good candidate for a concrete overlay. Consideration should be given to constructing a new pavement, including repairs to the subbase/subgrade where necessary.



Snyder & Associates, Inc., used with permission

Figure A-6. Low- to medium-severity pothole



Snyder & Associates, Inc., used with permission

Figure A-7. High-severity pothole

Summary of Possible Causes

A pothole may form in an area of alligator cracking as follows:

- As the alligator cracking becomes severe, the interconnected cracks create small chunks of pavement that can become dislodged as vehicles drive over them.
- When a pavement chunk is dislodged, the hole that remains develops into a pothole.

Required Pre-overlay Repairs

All potholes of any severity must be repaired with a concrete patch before overlay construction.

Raveling

Raveling is the wearing away of the pavement surface as aggregate particles are dislodged. The cause can be the hardening of the asphalt binder, a poor-quality mix, or poor compaction. In this type of distress, progressive pavement disintegration occurs from the surface downward.

For low- to medium-severity raveling (Figure A-8), the aggregate or binder has begun to wear away, but the disintegration has not progressed significantly. The surface is becoming rough or pitted with the loss of fine aggregate and some loss of coarse aggregate. Loose particles are generally present.

For high-severity raveling (Figure A-9), the aggregate or binder has worn away, and the surface texture is very rough and pitted. The loss of coarse aggregate is evident.

Summary of Possible Causes

Raveling is the result of a loss of bond between the aggregate particles and the asphalt binder, which may be caused by any of the following:

- Dusty aggregate (the asphalt binder bonds with the dust rather than the aggregate)
- Aggregate segregation (where fine particles are missing, the asphalt binder can bind only to the coarse particles at their relatively few contact points)
- Inadequate compaction during construction (a high density of compaction is required to develop sufficient cohesion within the asphalt)
- Mechanical dislodging by certain types of traffic such as studded tires, snowplow blades, or tracked vehicles

Required Pre-overlay Repairs

For low- to medium-severity raveling, remove all loose material by sweeping the asphalt surface, followed by cleaning with compressed air.

For high severity raveling, mill the surface to remove material with a vertical displacement of 1 in. or more to create a flat surface for the overlay.



Snyder & Associates, Inc., used with permission

Figure A-8. Low- to medium-severity raveling



Snyder & Associates, Inc., used with permission

Figure A-9. High-severity raveling

Thermal Cracking

Thermal cracking is a common form of asphalt pavement deterioration in cold climates. This type of distress is primarily caused by shrinkage of the asphalt during low temperatures combined with hardening of the asphalt binder. The cracks are weak zones where water seeps into and further damages the pavement structure.

Low- to medium-severity thermal cracks (Figure A-10) are $\frac{3}{4}$ in. wide or less or are wider but sealed.

High-severity thermal cracks (Figure A-11) are more than $\frac{3}{4}$ in. wide with vertical distortion.

Summary of Possible Causes

Cold temperatures produce thermal stresses in asphalt pavement. When the temperature drops, the asphalt binder in a pavement contracts more than the aggregate particles, causing the asphalt film to become thinner around the aggregates. When the temperature drops significantly, the asphalt binder becomes brittle and thermal cracking initiates.

Required Pre-overlay Repairs

For low- to medium-severity thermal cracking, seal any crack between $\frac{1}{2}$ in. and $\frac{3}{4}$ in. wide with crack sealant. If the width of a crack is greater than the maximum aggregate size of the overlay, fill the crack with flowable fill to prevent keying of the concrete overlay.

For high-severity thermal cracking, use flowable fill to repair any crack whose width is greater than the maximum aggregate size of the overlay. When noticeable vertical movement has occurred and the crack is greater than $1\frac{1}{2}$ in. wide, determine the cause of the drop and opening. If a subgrade or drainage issue is the cause, stabilize and drain the existing asphalt pavement prior to filling the crack.



Snyder & Associates, Inc., used with permission

Figure A-10. Low- to medium-severity thermal cracking



Photo: Snyder & Associates, Inc., used with permission

Figure A-11. High-severity thermal cracking

Random Cracking

Random cracking consists of diagonal, transverse, and longitudinal cracks. Generally, this type of cracking can be covered with a concrete overlay without reflecting through the concrete unless vertical or horizontal movement has occurred in the asphalt. When measurable crack movement is evident, the movement's causes should be determined and corrected before a concrete overlay is placed to prevent reflective cracking in the overlay.

Low- to medium-severity random cracks (Figure A-12) are $\frac{3}{4}$ in. wide or less and exhibit no historical vertical or horizontal movement.

High-severity random cracks (Figure A-13) are more than $\frac{3}{4}$ in. wide and exhibit historical vertical or horizontal movement.

Summary of Possible Causes

- Decreased support in the underlying subbase or subgrade
- Shrinkage of the underlying subgrade due to dry or cold weather
- Early manifestation of fatigue failure

Required Pre-overlay Repairs

For low- to medium-severity random cracking, fill any crack between $\frac{1}{2}$ in. and $\frac{3}{4}$ in. wide. If the width of a crack is greater than the maximum aggregate size of the overlay, fill the crack with fly ash slurry or concrete grout to prevent entry of moisture into the subgrade.

For high-severity random cracking, fill any crack between $\frac{3}{4}$ in. and $1\frac{1}{2}$ in. wide with fly ash slurry, concrete grout, or other nonasphalt material. When noticeable vertical movement has occurred and the crack is greater than $1\frac{1}{2}$ in. wide, determine the cause of the drop and opening. If a subgrade or drainage issue is the cause, stabilize and drain the existing asphalt pavement prior to filling the crack.



Snyder & Associates, Inc., used with permission

Figure A-12. Low- to medium-severity random cracking



Photo: Snyder & Associates, Inc., used with permission

Figure A-13. High-severity random cracking

Rutting

Rutting is a surface depression in a wheel path. Permanent deformation in any of a pavement's layers or its subgrade is usually caused by consolidation or lateral movement of the materials due to traffic loading. Specific causes of rutting can be insufficient compaction of asphalt layers during construction, subgrade rutting, or improper mix design or manufacture.

Low- to medium-severity rutting (Figure A-14) has a depth of 1½ in. or less and exhibits little or no fatigue cracking.

High severity rutting (Figure A-15) has a depth of more than 1½ in. and exhibits fatigue cracking.

Summary of Possible Causes

- Insufficient compaction of asphalt layers during construction (i.e., asphalt that is not sufficiently compacted initially may continue to densify under traffic loads)
- Subgrade rutting (e.g., as a result of inadequate pavement structure)
- Improper mix design or manufacture (e.g., excessively high asphalt content, excessive amount of mineral filler, insufficient amount of angular aggregate particles, or aggregate segregation)

Required Pre-overlay Repairs

A heavily rutted pavement should be investigated to determine the cause of failure (e.g., insufficient compaction during construction, subgrade rutting, poor mix design, or a large number of heavy trucks in truck lanes). If the asphalt is sufficiently thick, ruts and/or ridges greater than 1½ in. should be milled prior to concrete overlay placement. If the asphalt is not sufficiently thick for milling, areas of rutted asphalt should be removed and the concrete overlay thickened in these areas.



Snyder & Associates, Inc., used with permission

Figure A-14. Low- to medium-severity rutting



Snyder & Associates, Inc., used with permission

Figure A-15. High-severity rutting

Shoving (Slippage)

Shoving (slippage) is a form of plastic movement typified by ripples (corrugation) or an abrupt wave (shoving) across the pavement surface and is usually associated with vertical displacement, particularly in truck lanes. The distortion is perpendicular to the direction of traffic and usually occurs at locations where traffic starts and stops (corrugation) or where the asphalt abuts a rigid object (shoving).

Low- to medium-severity shoving (Figure A-16) occurs in small, localized areas.

High-severity shoving (Figure A-17) involves large areas indicative of asphalt failure.

If shoving is predominant throughout the parking lot, then the asphalt pavement is not a good candidate for a concrete overlay. Consideration should be given to constructing a new pavement, including repairs to the subbase/subgrade where necessary.

Summary of Possible Causes

- Braking or accelerating vehicles or a poor tack coat between asphalt lifts
- Unstable (i.e., low-stiffness) asphalt layer due to mix contamination, poor mix design, or lack of aeration of the liquid emulsion

Required Pre-overlay Repairs

For low- to medium-severity shoving, remove the pavement that exhibits vertical distortions and replace with concrete during overlay construction.

For high-severity shoving, remove the distorted pavement to the extent of the shoving.



Snyder & Associates, Inc., used with permission

Figure A-16. Low- to medium-severity shoving



Snyder & Associates, Inc., used with permission

Figure A-17. High-severity shoving

Appendix B. Fiber-Reinforced Concrete

On parking lots for lightweight vehicles such as automobiles and pickup trucks, the use of fiber reinforcement in thin concrete overlays (Figure B-1) is generally not necessary to achieve a durable pavement. Most such overlays can be cost-effectively designed and constructed to meet the desired design life without the use of fibers. However, fiber reinforcement should be considered in any of the following situations:

- The asphalt parking lot has specific vertical restrictions.
- The asphalt lift is very thin (and therefore may not readily bond with the concrete).
- The base thickness and/or condition is inadequate.
- The design thickness makes conventional reinforcement difficult to use.
- The design life needs to be increased.
- An increase in heavy-truck traffic is planned or anticipated.

During the last two decades, there has been a resurgence in the use of fiber reinforcement in concrete overlays of asphalt parking lots. The reason for this is that, properly used, newer fiber reinforcement technology can and does contribute to the performance of thin concrete overlays in parking lot applications. Whether the use of fibers is warranted should be determined based on the thickness and condition of the existing asphalt pavement and base, the owner's desired finish, the engineer's expected design life, and the overlay thickness. Additionally, since concrete overlays of asphalt parking lots are relatively thin compared to concrete overlays for highway applications, conventional reinforcement techniques are difficult to use. This is also making the use of fibers a consideration in concrete overlays.



Sherry Sullivan, FORTA, used with permission

Figure B-1. Close-up of concrete mixture with synthetic fibers

Why Fibers?

The fiber reinforcement in fiber-reinforced concrete (FRC) increases the concrete's structural integrity. FRC contains short, discrete fibers that are uniformly distributed and randomly oriented. The most common of these fibers include synthetic and steel fibers, though synthetic fibers have played a predominant role for the last two decades as the technology has improved. Other fiber types such as glass, cellulose, and natural fibers are occasionally used, but these are relatively rare and outside the scope of this document. Characterization of the fibers is normally based on fiber materials, geometries, distribution, and densities.

Used in sufficient dosages, fibers help increase, in engineering terms, the "toughness" and ductility of concrete. Enhancing the toughness and ductility provides flexibility to the designer, in that longer joint spacing and/or thinner sections of concrete can be used. Both options can be advantageous because they allow the designer to adjust designs to help control thickness for difficult grade problems or lower sawing costs by increasing joint spacing. A good understanding of the several different fiber technologies, which are described in the following section, permits the designer to better optimize designs for specific conditions.

Sufficient fibers to increase the toughness provide an additional benefit in controlling differential slab movement, since the fibers are typically contiguous through the cracks developed below sawed joints (Figure B-2). Plain concrete in overlay applications occasionally exhibits differential movement of the individual slabs as a result of temperature, curling/warping, or load-induced movement in the underlying asphalt. As a result, joints may open up or not line up; this is principally an issue of aesthetics but can affect performance when materials and conditions exacerbate curling/warping. In extreme cases, joints may fault in areas with high traffic volumes.



Sherry Sullivan, FORTA, used with permission

Figure B-2. Synthetic fibers spanning across a sawed joint

Synthetic fibers have been used successfully in controlling these problems for several years, though the long-term (greater than 15 years) duration of the benefit is not yet well established, particularly for synthetic fibers. Steel fibers have been around much longer and, provided corrosion can be kept in check or is not found to be objectionable on the surface, can be quite effective as well, but steel fibers have other disadvantages compared to synthetics.

An additional benefit of fibers is their ability to hold the inevitable cracks that will occur very tightly together. These cracks can occur from a variety of causes, but the fibers render the cracks more an annoyance than an actual problem; such tight cracks usually perform better than typical sawed joints. Good performance across cracks has been observed since fibers have been used in parking lot applications.

For concrete in a plastic state, fibers also offer the advantage of increased resistance to plastic shrinkage cracking. This type of cracking can occur in any concrete application when wind blows across the paved surface and the rate of evaporation exceeds the rate of bleed water coming to the surface of the concrete prior to setting. These conditions are somewhat more common in parking lot concrete overlay applications due to the construction techniques used.

Types of Fibers

The type of fiber to be used and the recommended dosages for specific types are evolving fairly rapidly.

Although steel fibers have a long history in paving applications, their addition to concrete using current technology requires significant manpower, which raises the cost of their use. Steel fibers also require more care to prevent balling of the fibers as a result of their tendency to sometimes clump together when exposed to cement and water (Figure B-3). The latter problem can be prevented with proper charging of the mixers, which may vary depending on the other materials in the concrete mixture.



Jeffery Roesler, University of Illinois at Urbana-Champaign, used with permission

Figure B-3. Balling of fibers in a concrete mixture

Synthetic fibers are generally broadly classed as macrofibers rather than microfibers, which are also common in the industry. Generally, synthetic macrofibers have been favored over steel fibers in the last few years due to their ease of handling and apparently better dispersion characteristics.

The aspect ratio (l/d) of a fiber is calculated by dividing the fiber's length (l) by its equivalent diameter (d). Fibers with a noncircular cross section use an equivalent diameter for the calculation of aspect ratio. The volume of fibers added to a concrete mix, termed the volume fraction (vf), is expressed as a percentage of the total volume of the concrete-fiber composite. The volume fraction typically ranges from 0.1 to 3.0 percent.

For current design technology, the dosage of fiber, whether synthetic, steel, or some blend, is specified to produce certain behavior characteristics in the hardened concrete. These characteristics correlate with forecasts of improved performance, such as the way increased residual flexural strength enhances fatigue capacity.

It should be noted that the actual strength of concrete, given the current technology, increases only slightly, if at all, through the addition of fibers. Concrete will still crack if the load exceeds that which can be borne mechanically at the concrete's upper strength limit given the geometric properties of the section, but the section will carry a much greater number of lesser loads up to that point and, through the fibers' ability to bridge cracks, will continue to carry loads beyond that point. Furthermore, with the appropriate fiber and dosage, the crack widths will be lessened and the crack patterns will be different; typically, more tight cracks will form, many of which will not be visible and thus will not pose a performance or aesthetic problem. Discussions of the specific characteristics and behaviors of FRC are beyond the scope of this document, but a simple way to articulate the point is to think of concrete with fibers as being effectively stronger than the strength measured in a beam test.

This effect varies as a function of fiber dosage, not in terms of the weight of the fibers but in terms of their volume in the concrete mixture. Steel fibers, which have a much higher density than synthetic fibers, weigh much more than synthetic fibers at the same volume in the concrete mixture; conversely, synthetic fibers at the same volume weigh much less. However, it may also take a higher volume of one fiber compared to another to provide the same improvement in pavement performance.

For this reason, it is important to know the type of fiber being used, the volume of that fiber needed in the mixture to produce the desired properties, and the fiber's specific gravity. This information is essential so that the concrete producer, who batches concrete by weight rather than volume, can produce a unit volume of concrete that has the appropriate behavior characteristics upon setting.

Synthetic macrofibers starting at a minimum dosage of 4 lb/yd³ have shown success in several parking lot overlay applications. For a typical concrete mix, this dosage is about 0.26 percent by volume. For comparison, the same volume of steel fibers would weigh about 34 lb/yd³ but yield somewhat different characteristics in the concrete.

Fiber producers and suppliers can be of assistance in this area since, as mentioned above, fiber technology is undergoing a rapid evolutionary phase. Various blends of fiber technologies are being introduced that combine steel and synthetic fibers. Also, higher modulus synthetics are under development that may further advance the technology in the future. A good reference and some minimum recommended dosages for specific classes of fiber based on the current state of understanding can be found in the Illinois Department of Transportation's qualified product list (IDOT 2022).

High-Volume Synthetic Macrofiber Mixtures

Certain types of synthetic macrofibers in quantities greater than 4 lb/yd³ can provide for a reduction in overlay thickness, enhance post-crack flexural performance, and, in some cases under high doses, actually allow the concrete to become yielding in nature and to flex somewhat under loads.

At higher dosages, however, care must be taken to avoid clumping of the fibers in the mix. Mix adjustments such as changes to the aggregate gradation, cement content, and admixture type and dosage are necessary to accommodate the higher fiber contents. Concrete mixtures with a high volume (5.0 to 7.5 lb/yd³) of synthetic macrofibers (typically with lengths of 1.5 to 2.25 in.) ideally should utilize well-graded aggregates. In addition, due to the fibers' large surface area compared to their volume, such mixtures may require slightly more cementitious material (an additional 20 to 50 lb/yd³), slightly more water to keep the same water-to-cementitious materials (w/cm) ratio, and in some cases slightly more fine aggregate.

Construction Considerations When Using Fibers

The addition of fibers will typically reduce slump 2 to 4 in. in a concrete mixture, with everything else being equal, due to the fibers' length and their relatively large volume within the mixture. However, the use of fibers will generally not reduce workability. To a concrete finisher or ready mix concrete truck driver casually observing the discharge of the first load of concrete, this reduced slump can nevertheless trigger a natural instinct to add water to the mixture to make it easier to place. In reality, an appropriately designed mixture responds well to mechanical vibration.

If needed, a moderate dose of a water reducer followed by a polycarboxylate (if necessary) can be used to offset any loss in workability, especially for fiber dosages of 5.0 lb/yd³ and greater. Not all mixes that contain fiber require admixtures, however, with the necessity of admixtures depending on the mixture, fiber type, and fiber dosage. The admixture supplier should be contacted for recommendations regarding the use of admixtures with mixtures containing fibers.

During construction, a few other items may warrant attention when using fibers, and these characteristics are further exacerbated as the fiber dosage increases:

- The use of fibers may require slightly delayed contraction joint sawing due to the fibers' tendency to increase susceptibility to joint raveling if sawing is not timed properly.
- The use of fibers adds costs to the preparation and placement of the concrete mixture. For this reason, their use must be weighed against other costs and factors, such as the cost of increasing the overlay thickness without the use of fibers and the savings that might be gained from a possible reduction in the number of sawed joints, better joint performance, the ability to minimize grade changes, and increased design life.

- Fibers can negatively affect the finished appearance of the concrete pavement surface if care is not taken with the fiber type, mix design, and texturing technique. However, with proper care, the finished appearance will be acceptable. Owners need to be made aware up front that if fibers are used, the concrete surface will appear slightly different than the clean, smooth surface usually expected to result from concrete paving. Some contractors pan finish the surface to embed the fibers prior to texturing. This is not recommended because humidity, wind, sun, shade, temperature, and rain can all affect this operation. Furthermore, if the panning is not properly done, a significant amount of the entrained air can be removed, thereby reducing the concrete's freeze-thaw durability.
 - Heavy doses of fiber can make the concrete pavement surface difficult to keep clean due to the slight roughness created by the fibers that manage to find their way up through the surface. The "hairy" surface resulting from these fibers can occur at higher fiber dosages if the care noted above regarding fiber type, mix design, and texturing technique is not taken. If the fiber dosage is lower, the FRC can be easier to finish. Over time, the surface fibers themselves will wear away and disappear, but the small amount of roughness immediately around the fibers may remain. This is not something that is noticeable at highway speeds, but for pedestrians walking across commercial parking lot applications, the roughness can be evident. If this texture is objectionable, it can be removed using a simple pan flame torch.
 - Skid-resistant or higher friction surfaces are often specified for paving applications. However, some fibers can create unsightly finishes after texturing depending on which fiber type and dosage amount are chosen. Typically, pavements are placed with a truss screed or laser-guided screed, and brooms are sometimes pulled 50 ft or more. Generally, an acceptable broom finish can be achieved with a proper mix design, a suitable fiber, an appropriate broom kept relatively clean, one-directional broom passes, and no "jiggling" of the broom. Testing a small, remote area in the parking lot is a good idea so that agreement is reached on an acceptable surface during the first placement operation. One method for brooming that has proved to be effective is to hold the head of the concrete broom at 45 degrees, pull the broom in one direction, and clean the broom after each pass. Timing is critical; brooming too soon will pull the fiber to the surface.
 - Unless measures are taken to prevent balling, fibers may occasionally ball up and create a surface defect (see Figure B-3) even if added to the ready mix discharge load under the utmost care. Some contractors drill out any areas where the fiber has balled with a 4 in. core drill to a depth of approximately 1 in. This allows for the balled fiber to be removed and replaced with a grout or concrete mix. If fiber balling is encountered, a review of the mixing sequence is recommended.
 - The use of older types of high-range water reducers (HRWRs), such as naphthalenes and melamines, to reduce the water-cement ratio should be limited because they tend to cause bleed water to accumulate and exacerbate spotty concrete setting, thereby possibly making the fibers more prominent in the pavement surface. The newer HRWRs (polycarboxylates) are generally better in this regard and reduce segregation effects in the mixture (both fiber and aggregate related).
- Finally, it is important that the product being used is thoroughly understood. Fibers are an excellent tool for enhancing concrete overlays of existing asphalt parking lots, but the products are rapidly evolving, and many owners, contractors, and producers are still learning how to best apply the technology. When synthetic macrofibers are used, a trial mix should be batched and placed at the ready mix producer's facility or placed elsewhere using the ingredients and proportions approved for the project so that all stakeholders know and understand what is expected. Communication with the owner, general contractor, and inspectors is important to let them know what to expect during and after construction.

Appendix C. Key Points Related to Materials and Construction

The tables in this appendix summarize key topics related to concrete overlays of asphalt parking lots. The topics are organized into categories on materials and mixtures, pre-overlay repairs and surface preparation, and construction.

Materials and Mixes

Table C-1 summarizes key topics related to the materials and mixtures used in concrete overlays of asphalt parking lots.

Table C-1. Key points related to the materials and mixes used in concrete overlays of asphalt parking lots

Topic	Objectives/Expectations	Considerations/Limitations
Cement	Hydraulic cements include portland cement and blended cements that contain supplementary cementitious materials (SCMs). Type I or Type II cements are the most common cements in concrete overlays of asphalt parking lots. Type I is a general purpose cement suitable for all uses where special properties are not required. Sometimes Type II cements are used to help protect the concrete against moderate sulfate attack.	The use of Type II cement in concrete must be accompanied by the use of a low water-to-cementitious materials (w/cm) ratio and low permeability to control sulfate attack. Blended cements with moderate sulfate (MS) resistance or high sulfate (HS) resistance may also be used in sulfate-exposed environments.
Slag cement (Type IS)	Slag cement can effectively reduce expansion due to alkali-silicate reactivity (ASR), increase long-term strength, reduce permeability, reduce concrete temperature, and slow hydration.	Because slag cement may reduce the rates of early strength gain and hydration, some cold-weather states recommend restricting the amount of slag cement used in mixtures for projects constructed in cold weather.
Fly ash	Fly ash increases long-term strength, reduces permeability, and reduces set temperature. Some fly ash can slow hydration on construction projects.	Because fly ash can reduce the rates of early strength gain and hydration, some owners in cold-weather regions recommend restrictions on the use of fly ash in cold weather.
Type C	Type C fly ash increases long-term strength and reduces water demand and permeability. This may or may not slow hydration or reduce expansion due to ASR.	Type C fly ash can affect strength gain. Too high a dosage may increase the risk of rapid stiffening and/or damage due to salt scaling. Mixtures must be tested to determine how much Type C fly ash is required to reduce expansion related to ASR.
Type F	Type F fly ash increases long-term strength and reduces permeability. It also slows hydration and helps reduce expansion due to ASR.	Type F fly ash delays setting and reduces the rate of strength gain. The high loss on ignition affects air entrainment. Type F fly ash is generally effective at reducing expansion related to ASR. Availability may be limited.
Chemical admixtures	Chemical admixtures are added to concrete mixtures to modify certain concrete properties such as strength. Adding chemical admixtures can achieve these properties more efficiently than adjusting other mixture ingredients such as the type of cement. Combined admixtures that contain both water reducers and accelerators are available.	The effects of set-modifying admixtures on other properties of concrete, like shrinkage, may not be predictable. Therefore, acceptance tests of set modifiers should be made with job materials under anticipated job conditions. Compatibility of the admixtures with other ingredients should be tested for potential constructability problems.
Water reducers	Water reducers lower water demand in order to reduce paste content (lowering w/cm ratio) to help minimize shrinkage, temperature, and cracking without sacrificing workability. Water-reducing admixtures can also increase early strength gain by lowering the quantity of water necessary for cement hydration (by as much as 10%). Typical recommended w/cm ratios are ≤ 0.45 . Water reducers also aid in the mixing of fibers to achieve proper dispersion.	Confirm that water reducers are compatible with other chemical admixtures and cements, particularly under harsh environmental conditions. Confirmed laboratory testing is essential to determine if the admixtures will develop the desirable properties. Types F and G high-range water reducers are not normally used in parking lot pavements because of their high cost and the difficulty of controlling the mixture's slump range required for slipform paving. Overdoses of water reducers, particularly normal-range products, may severely retard or prevent setting.
Accelerators	Accelerating admixtures are used to increase the rate of strength development of concrete at an early age, including in cold weather. It is important to test both fresh and hardened concrete properties before using accelerators in bonded overlays.	Accelerators may lower long-term strength. Excess acceleration may result in cracking before finishing and/or sawcutting can be completed. Care must be exercised in using accelerators in thin overlays so as not to cause early shrinkage, cracking, and high degrees of curling and warping.
Air-entraining admixtures	Concrete in parking lots subject to freezing and thawing should be air entrained. Air entrainment dramatically improves the durability of concrete exposed to moisture during cycles of freezing/thawing and improves resistance to surface scaling caused by chemical deicers. It also tends to improve the workability of concrete mixtures, reduce water demand, and decrease mixture segregation and bleeding.	Compatibility with other admixtures must be checked. For about every 1% of air entrained, about 5% of concrete compressive strength is lost. When the loss of air through the paver approaches 3%, the air system (quantity and distribution) may not be acceptable, and a hardened air void sample should be taken. The minimum air content after placement should be 5%.
Retarders	Retarders are useful in extending set times. They increase the bleed rate and capacity and may be accompanied by some reduction in early-age strength gain (one to three days) but higher later strengths.	Retarders can lengthen the time window that a concrete slab may be vulnerable to plastic shrinkage cracking and rain damage. Retarders are sometimes used to try to decrease slump loss and extend workability, but this application is incorrect because, under certain conditions, the opposite results can occur.

Table C-1 continued on following page

Table C-1 continued from previous page

Topic	Objectives/Expectations	Considerations/Limitations
Aggregates	<p>Aggregates selected for paving should be durable to freezing and thawing exposure and should not contain porous cherts in excess of applicable specification limits. Coarse aggregates meeting ASTM C 33 or local highway department specifications for concrete paving normally provide acceptable in-service performance. Refer to ACI PRC-221-96 (ACI Committee 221 2001) for additional guidance.</p> <p>It is critical that the aggregate be well graded (that is, there should be a wide range of aggregate sizes). Well-graded aggregate has less space between aggregate particles, thereby reducing paste demand without loss of workability. Reduced paste content reduces shrinkage and early-age cracking, particularly with accelerated mixes.</p>	<p>Aggregate is subject to varying conditions in storage and handling. At the very least, these changes should be anticipated, and accommodations should be made to adjust the water content in the mixture as necessary. Ideally, real-time monitoring of the aggregate moisture content would allow for on-the-fly changes. In most circumstances, a well-regulated sampling program using rapid evaluation equipment will improve this component of the process considerably.</p> <p>Potential ASR and D-cracking have become important durability considerations for aggregates. Aggregates that test positive for potential ASR should only be used if mitigation procedures are in place. These include the use of low-alkali cements, pozzolans, slag cement, and blended cements that have proven their effectiveness in ASR test programs. The best evidence of an aggregate's potential ASR properties is its service record for 10 or more years, per ACI PRC-221-96 (ACI Committee 221 2001). Aggregates that have tested positive for D-cracking should not be used.</p>
Fibers	<p>Consideration should be given to using fibers for concrete overlays of parking lots. Fibers improve the toughness of the concrete overlay and its resistance to plastic and dry shrinkage cracking, particularly with bonded overlays.</p>	<p>Inclusion of fibers in the mixture must be accomplished in a way that prevents their balling into clumps. In some cases, water-soluble bags are added to the final batch. A staging area may be needed with adequate capacity to avoid a queue. In other cases, individual (bulk) fibers may be introduced into the mixture; in this situation, a blower, pneumatic fiber feeder, and/or conveyor belt appropriate to the application should be considered.</p>
Mixing and batching	<p>Batching of the concrete used in concrete overlays of parking lots is usually no different than the batching used in conventional concrete paving with ready mix applications. Concrete for parking lot pavements should be batched, mixed, and delivered in accordance with ASTM C 94/C 94M or C 685/C 685M. The components of the mixture should follow the requirements contained in other appropriate ASTM specifications.</p> <p>Proportioning the concrete according to the methods used in ACI PRC-211.1-91 (ACI Committee 211 2009) will help ensure that the concrete will provide the required strength, long-term durability, economy, and workability envisioned by the parking lot owner, designer, and contractor. ACI SPEC-301-20 (ACI Committee 301 2020) may also provide useful guidance. ACI PRC-304-00 (ACI Committee 304 2009) contains guidance on batching, mixing, and placing.</p>	<p>The proportions for the concrete can be established on the basis of laboratory trial batches. For most small parking lot projects, the effort and expense required to establish proportions by laboratory trials may not be justified if commercial concrete with the requisite performance history is available. Commercial mixtures proportioned and approved for use in state, city, or county paving will usually be adequate for parking lots. Concrete producers normally have standard mixtures with performance records that are appropriate for parking lot projects.</p>
Capacity	<p>Having adequate batching capacity is an important link in the process of constructing a concrete overlay. Both mixing time and the availability of transport equipment should be balanced along with cost.</p>	<p>Contingency plans should include preparation for rapid responses to (repairs of) the more common equipment malfunctions.</p>
Consistency	<p>During batching, consistency and uniformity are critical. Adequate mixing time should be balanced with the need for increased production rates.</p>	<p>Bonded concrete overlays are particularly vulnerable to changes in material properties due to their commonly thin sections.</p>

Pre-overlay Repairs and Surface Preparation

Table C-2 summarizes key topics related to pre-overlay repairs and surface preparation for concrete overlays of asphalt parking lots.

Table C-2. Key points related to pre-overlay repairs and surface preparation for concrete overlays of asphalt parking lots

Topic	Objectives/Expectations	Considerations/Limitations
Spot repairs	<p>Some projects will require spot repairs to the existing asphalt pavement. If extensive repairs are required, the parking lot is not a good candidate for an overlay.</p> <p>Spot areas with potholes, localized moderate to severe alligator cracking, or loss of base/subgrade support may require partial- or full-depth repairs to achieve the desired load-carrying capacity and long-term durability. Full-depth repairs are effective at correcting many different types of localized distress.</p> <p>The quality of spot repairs will often be critical to the successful performance of the concrete overlay system.</p>	<p>Asphalt patches do not bond well with concrete overlays, so concrete patches are recommended. Patching should be completed after any required milling.</p> <p>Whether a concrete patch is placed separately or placed at the same time as the overlay (i.e., in a single paving operation), the result is a spot section of thicker concrete. This thicker section of concrete will move differently from the adjacent asphalt, so no single overlay panel should be over both asphalt pavement and the concrete patch. The normal jointing pattern of the overlay will need to be adjusted to isolate the section over the concrete patch.</p> <p>The effectiveness of a repair is dependent on the proper repair size. Most parking lot repairs are a minimum length of 4 to 6 ft.</p> <p>Salvaging the existing dowel system is not recommended.</p> <p>All delaminated asphalt should be removed, and no asphalt around the repair boundaries should be damaged.</p>
Crack repairs	<p>Concrete should span most of the longitudinal and transverse cracks in the asphalt during construction of the bonded overlay. In isolated areas with a high number of wide transverse cracks such as thermal cracks, the cracks can either be bridged with the overlay or cleaned and filled prior to the overlay.</p>	<p>Filling old cracks with fly ash slurry, concrete grout, or other appropriate material is only necessary for cracks that have an opening greater than the maximum aggregate size used in the overlay.</p>
Milling	<p>The main objectives of milling are to (1) remove significant surface distortions that contain soft asphaltic material, which would result in an inadequate bonding surface; (2) reduce high spots to help ensure minimum overlay depth and reduce the quantity of concrete needed to fill low spots; and (3) match the elevations of curbs or adjacent structures. Milling may also be considered to roughen the surface and enhance bonding.</p> <p>In general, milling of the asphalt should be minimized because it results in the loss of structural support. The objective is not to obtain a perfect cross section or to completely remove ruts. Note that heavy rutting and/or fractured cracking are typically caused by truck traffic. In truck traffic routes separate from typical light traffic parking areas, a separate overlay of increased thickness should be placed.</p>	<p>Most surface distresses can be removed through milling. Milling should be used where surface distortions are 1.5 in. or greater.</p> <p>The amount of asphalt removed depends on the types and severity of distresses and the thickness of the asphalt. It is important to ensure that the milling depth does not compromise the bonding effectiveness of the asphalt tack lines between existing asphalt lifts. Therefore, milling should remove asphalt to the nearest tack line. A minimum of 2 in. of asphalt should remain after milling, and the milling depth should be no less than 1 in. from a tack line.</p> <p>An adequate layer of asphalt is required to prevent delamination and thus ensure that the asphalt will function as a load-carrying portion of the composite pavement (and not as a separation layer or shear plane, as in an unbonded overlay).</p> <p>While the milling machine is still on site after a milling operation, the pavement surface should be inspected to determine whether additional milling is required.</p> <p>After milling, the surface should be inspected for isolated pockets of deterioration that require further repairs. In spot areas that still exhibit some loss of structural integrity, the poor asphalt should be removed and the overlay thickness increased.</p>
Retrofitted edge drains	<p>A good candidate project for retrofitted edge drains is a parking lot that is showing early signs of moisture damage and is relatively young (i.e., less than 10 years old). If the pavement has experienced significant distress due to moisture, it may not be a good candidate for a retrofit of drainage and may also not be a good candidate for a concrete overlay.</p>	<p>When placing corrugated polyethylene pipes, extra care is required to prevent overstretching the pipes during installation. To avoid damage to the pipes during compaction, a minimum of 6 in. of cover over the drainage pipe is recommended before compacting.</p>
Surface preparation/cleaning	<p>Following repairs, the asphalt surface needs to be clean and dry to ensure adequate bonding.</p> <p>Cleaning can be accomplished by first sweeping the asphalt surface, then cleaning with compressed air. Pressure washing should be considered only when dust control is mandated or when mud has been tracked onto the milled surface.</p>	<p>In no case should water or moisture be allowed to stand on the asphalt pavement prior to overlay placement.</p> <p>To prevent contamination, it is important to avoid a lengthy lag time between final surface cleaning and overlay paving.</p>
Traffic on prepared surface	<p>Surface preparation operations can be phased to allow for intermediate levels of traffic and passenger-type vehicles on the surface prior to overlay placement.</p>	<p>If traffic is allowed on the prepared surface prior to overlay placement, subsequent cleaning of the surface is required, particularly for bonded overlays, in order to remove any potential contamination.</p>

Construction

Table C-3 summarizes key topics related to the construction of concrete overlays of asphalt parking lots.

Table C-3. Key points related to the construction of concrete overlays of asphalt parking lots

Topic	Objectives/Expectations	Considerations/Limitations
Planning and coordination	Parking lots should be constructed in compliance with adequate plans and specifications to provide a pavement that will meet the owner's needs. Because the contractor is responsible for providing quality workmanship, ACI-certified finishers and compliance with ACI PRC-121-08 (ACI Committee 121 2008) are recommended. This is especially important on small projects that are likely to be constructed with little or no inspection.	A preconstruction conference should be arranged involving the owner, designer, contractor, and subcontractors, including the concrete supplier. The objectives are to coordinate the contractors, determine the type of equipment needed for the project, arrange for a realistic delivery rate of concrete, determine the construction sequence, arrange delivery routes for concrete trucks, and review anticipated weather conditions.
Staging area	The locations of adequate staging areas should be determined within the project limits. Staging areas are necessary for ready mix truck washouts, storage of equipment and materials, construction trailers, and possibly a portable concrete mixing plant.	Additional construction costs and user delays for construction under traffic must be compared to the costs of travel delays and extra mileage due to detours.
Plans for construction	A layout that permits efficient use of paving equipment, provides access for concrete delivery trucks, and ensures site drainage can expedite construction operations. The contractor and engineer should agree on joint layout and construction methods before paving begins; a drawing of the joint locations and paving sequence is helpful. The locations of drainage fixtures, lighting supports, and other fixed objects should be established with joint patterns and construction methods in mind.	Paving should be carried out using block placement or strip placement; see Placement of Parking Lot Overlays in this guide for more on these placement methods. When strip placement is used, paving-lane widths should be in multiples of the joint spacings. The specific widths will depend on the equipment and method selected by the contractor. Checkerboard placement is not recommended and should be avoided because it requires more time and forming materials and usually results in less consistent surface tolerances and poorer joint load transfer. See Placement of Parking Lot Overlays in this guide.
Equipment	For information on the equipment used in concrete overlay construction, see Equipment for Parking Lot Overlay Placement in this guide.	
Concrete placement	When the surface temperature of the asphalt is at or above 120°F, surface watering can be used to reduce the temperature and minimize the chance of fast-set shrinkage cracking in the overlay. No standing water should remain on the surface of the asphalt at the time the overlay is placed. Water trapped in the milled surface can be blown off with compressed air. Paving is accomplished using either a conventional fixed-form laser-guided screed or slipform construction, depending on the size of the project and the geometric constraints. Because of variations in the concrete thickness, the concrete material is paid for on a cubic yard basis. Placement is paid for on a square yard basis.	The concrete should be deposited as uniformly as possible ahead of the paving equipment and as close to its final position as possible to minimize the amount of rehandling required. The concrete should be consolidated along the faces of the forms and struck off to the required elevation and cross section. If slipform equipment is used, the concrete should be of a consistency necessary to prevent noticeable edge slump. Workability is an important consideration in selecting concrete for a parking lot paving project. The slump for slipform paving is usually 1½ in. or less. Concrete to be placed by hand or with vibrating screeds requires a higher slump, generally 4 in. or less. Water content, aggregate gradation, admixtures, and air content are all factors that affect workability. The recommended w/cm ratio is 0.45 or less. The maximum aggregate size should be no greater than one-third the thickness of the slab.
Finishing and texturing	The surface should be finished only as much as necessary to remove irregularities. Immediately following strike-off, the surface should be leveled with a bullfloat or a scraping straightedge. All edges, tooled joints, and isolation joints should be rounded to the specified radius using appropriate tools. The use of hand or power floats and trowels is not necessary and is not recommended because their use can result in scaling.	As soon as the finished concrete has set sufficiently to maintain a texture and no bleed water remains on the surface, the surface can be dragged with a short length of damp burlap or other material such as synthetic turf carpeting. Drags are sometimes attached to paving machines or screeds. As an alternative, the surface can be broomed to develop a skid-resistant surface and uniform appearance.

Table C-3 continued on following page

Table C-3 continued from previous page

Topic	Objectives/Expectations	Considerations/Limitations
Curing	<p>Curing is arguably more critical for concrete overlays than for most other concrete paving projects. The relatively thin nature of overlays increases their surface area with respect to their volume. The result is a greater susceptibility to excess moisture loss and the resulting distresses. Improper coverage of curing compound can result in plastic shrinkage cracking, full-depth shrinkage cracking, wide joints, and surface distresses.</p> <p>Because of the wide area being paved, the proper application of curing compound on a parking lot overlay is more difficult than on a roadway overlay. Therefore, care must be taken to ensure that a uniform and thorough coating of curing compound is applied, especially in cold weather.</p>	<p>The application of white-pigmented membrane-forming curing compounds meeting the requirements of ASTM C 309 or C 1315 (Type II) should follow normal curing procedures as recommended by the manufacturer. After finishing and texturing operations have been completed and immediately after any free water has evaporated, the surface of the slab and any exposed edges should be uniformly coated with a high-solids curing compound. For hot/cold weather protection, see ACI PRC-330-21 (ACI Committee 330 2021). In general, within 30 minutes of placing the overlay, curing compound should be applied at twice the standard rate. The finished product should appear as a uniformly painted solid white surface with no gray areas and with the vertical faces along the edges of the overlay thoroughly coated.</p>
Special curing	<p>For overlays that require very fast opening to traffic and that are relatively short in length, special curing in addition to the application of curing compound is used. Special curing normally consists of insulating blankets that provide a uniform temperature environment for the concrete.</p>	<p>Special curing is normally not required in summer months for accelerated construction, but it does have an effect on strength gain when air temperatures are less than 65°F, and it has a pronounced effect when temperatures are less than 55°F in colder months.</p>
Jointing	<p>The jointing of concrete overlays is a critical operation. The thin overlay lift (compared to that of a new pavement) often gains stresses rapidly and thus requires accelerated sawing. Sometimes the need for accelerated sawing is underestimated, and sawing operations fall too far behind the paver. The contractor should be prepared with the proper type and number of saws. In the case of jointing, redundancy in equipment is important.</p>	<p>Sawcutting operations should be timed to balance the potential for uncontrolled cracking with the potential for excessive joint spalling during sawing. Bonded concrete overlays require the most effective sawing operations to prevent overlay failures. For overlays on asphalt, particularly when there is wheel rutting in the asphalt, the depth of the sawcut should be increased to account for the extra depth of concrete in the rutted areas.</p>
Fillets	<p>Fillets provide a level of safety precaution at drop-offs.</p>	<p>Placement of form fillets may require sawing.</p>
Maturity method for strength testing/opening	<p>Maturity testing for accelerated construction provides a reliable technique for estimating in-place strength and thus the time of opening to traffic. The temperatures measured as part of maturity testing have also been shown to be effective in identifying potential changes to the concrete mixture.</p> <p>Maturity testing provides a reliable technique for continuous monitoring of concrete strength gain. Most importantly, maturity testing enables any pavement to be opened to traffic as soon as it meets the appropriate strength criteria. Concrete maturity testing concepts are being applied by 32 states.</p>	<p>Development of a maturity curve is an important element of maturity testing. As construction proceeds on a project, validation of the maturity curve may be necessary when changes occur in mixture constituents, material sources, mixture operations, or w/cm ratios.</p> <p>Additionally, some states set an automatic validation criterion based on a time period. Most states that use a maturity curve have established validation criteria, which allows some flexibility in mixture changes without the development of a new maturity curve.</p>
Opening strength	<p>No simple field test is available to measure the strength of the concrete-asphalt bond. Instead, a value for the opening strength of the concrete between 420 psi flexural (2,500 psi compressive) and 480 psi flexural (3,000 psi compressive) seems to be reasonable.</p>	<p>An additional consideration for accelerated construction is to encourage concrete-asphalt bonding via milling of the existing asphalt surface. If shear failures do occur, they will likely occur in the asphalt, since the concrete shear strength is greater than the asphalt shear strength.</p>

National Concrete Pavement
Technology Center

